

# User Manual



**OXYREVO**

[www.oxyrevo.com](http://www.oxyrevo.com)

# Safety Notice

To ensure safety, please read the following precautions before using,

## Warning:

- If abnormal smell during use, please turn off the power and pull out the plug
- Please make sure the socket plug is fully inserted
- Please do not disassemble the machine without permission from the supplier
- This product must not be exposed to water, fire, or sharp objects
- Child use under adult care only
- Please do not touch any valves on the chamber when in use
- Please do not place heavy objects on the machine
- Do not use if the power cord is loose
- Do not pull or twist the power cord
- Keep wet hands away from the unit
- Do not use it in a bathroom or other damp environment

## Do not use under the following conditions:

- Pregnant women and people with severe infectious diseases
- Bad colds and Pneumothorax patients
- Patients with severe emphysema
- Hypertension exceeds 160 / 100mmHg
- Severe heart problems

\*It is recommended to turn on your room air conditioner when your room temperature is above 20 °C for better comfortable cooling using experience .

## Notice:

1. When the pressure is rising in the chamber, your ears may sense the pressure, similar to the feeling of taking a plane up and down.

This is normal. The following methods can be used to relieve the pressure,

- a) Chewing gum.
  - b) Yawning.
  - c) Pinch nose and blow against a closed mouth until the pressure stabilizes.
- Any discomfort will gradually disappear.

2. Zippers can be opened ONLY when the chamber has been depressurized to 0kPa.



Open the Valve

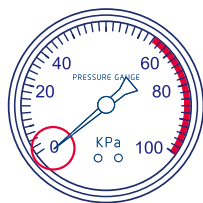

Make sure that Pressure Gauge appears 0 kPa

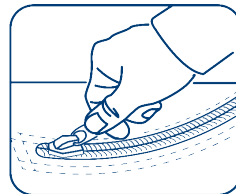

Pull the zippers

3. After exiting the chamber, turn off power to the unit.

# Specifications

## 1. Chamber Capsule

① Window	⑦ Emergency Pressure Relief Valve
② Zippers	⑧ Spare Valve
③ External Pressure Gauge	⑨ Metal Base
④ Internal Pressure Gauge	⑩ Air Inlet Valve
⑤ Pressure Deflate Valve	⑪ Oxygen Inlet Valve
⑥ Pressure Switch Valve	⑫ Automatic Pressure Relief Valves

Model	Wheelchair Hyperbaric Chamber Heal40
Specification	
Size	168*168*190cm
Pressure	1.4ATA(40kPa)
Weight	95Kg(includes base)

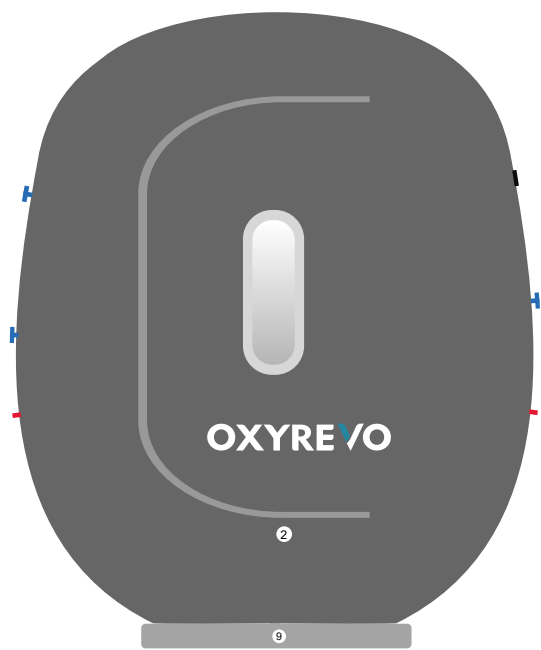
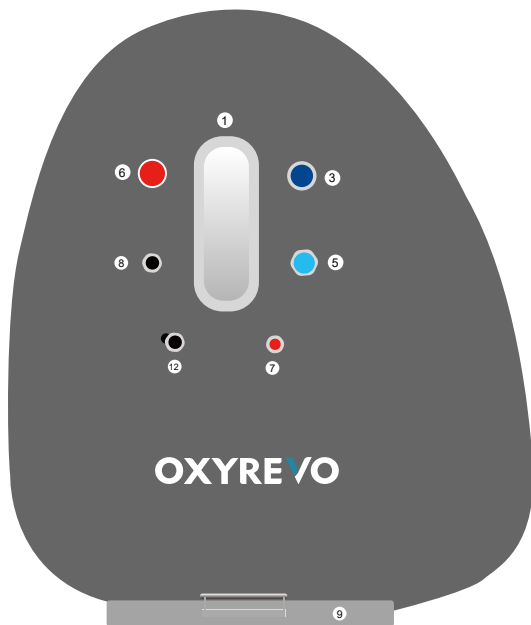

# Specifications

## 2. Operating Unit of All-in-one Machine

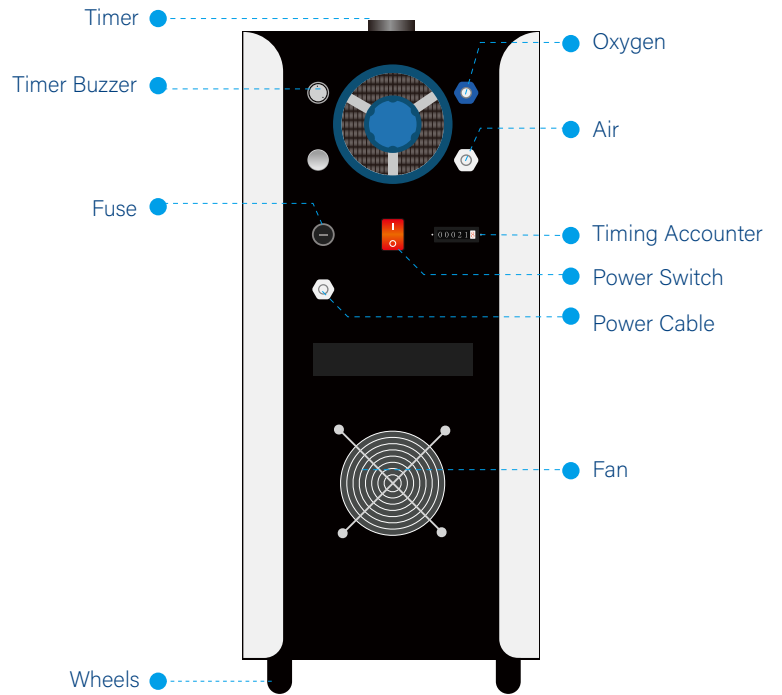
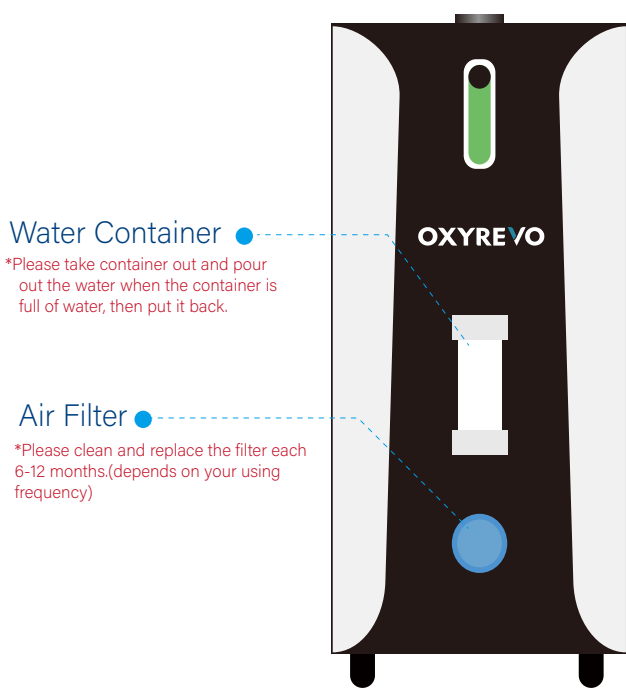

Voltage	230V
Power	1400W
Weight	80KG
Air Flow	85L/Minute
Oxygen Flow	10L/Minute





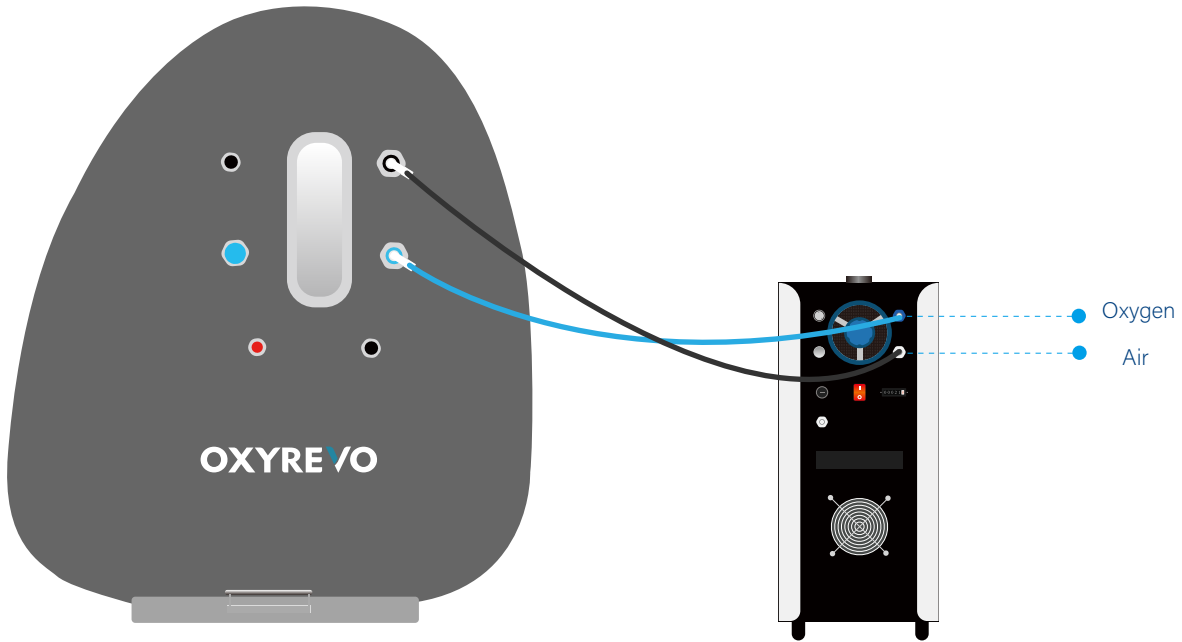

ALL-IN-ONE-MACHINE, INCLUDES,  
 1 x Air Compressor  
 1 x Oxygen Concentrator  
 2 x Cooling Machines  
 1 x Anion  
 1 x Air Purifier/Anti-virus System(Optional)  
 1 x Timer  
 1 x Timer Alarm

Make all function in one combination by one press!

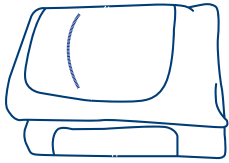
\*The timer buzzer will give an alarm after timer time ends when you use timer, please screw the timer button to point to "ON" position to turn off it.

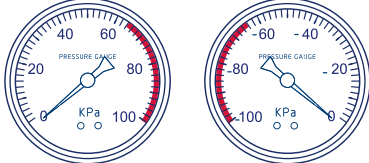
## Working Schematic

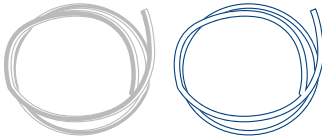
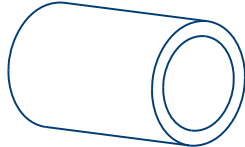
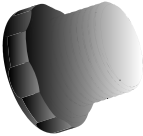
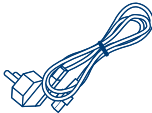

 <p>Chamber with Metal Base</p>	 <p>Silencer</p>	 <p>Internal/External Pressure Gauge</p>
 <p>Metal Frame</p>	 <p>Air/Oxygen Tube</p>	 <p>Activated Carbon Cotton Filter</p>
 <p>Spare Valve</p>	 <p>Power Cable</p>	 <p>Oxygen Mask</p>

1. Install the frame inside of the chamber.

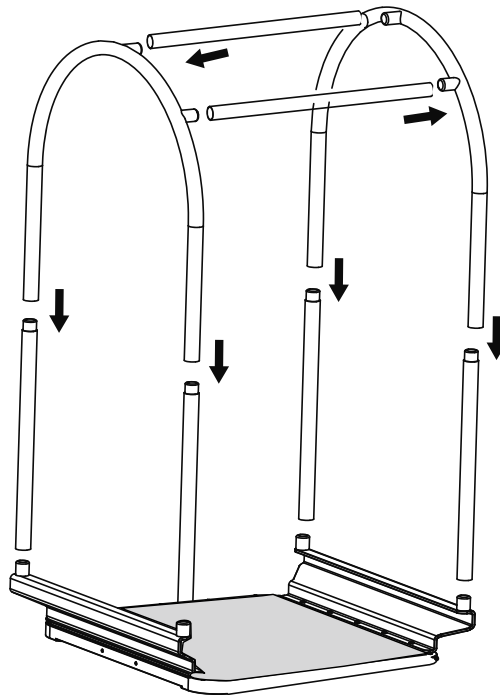

2. Install the Internal/External Pressure Gauges.

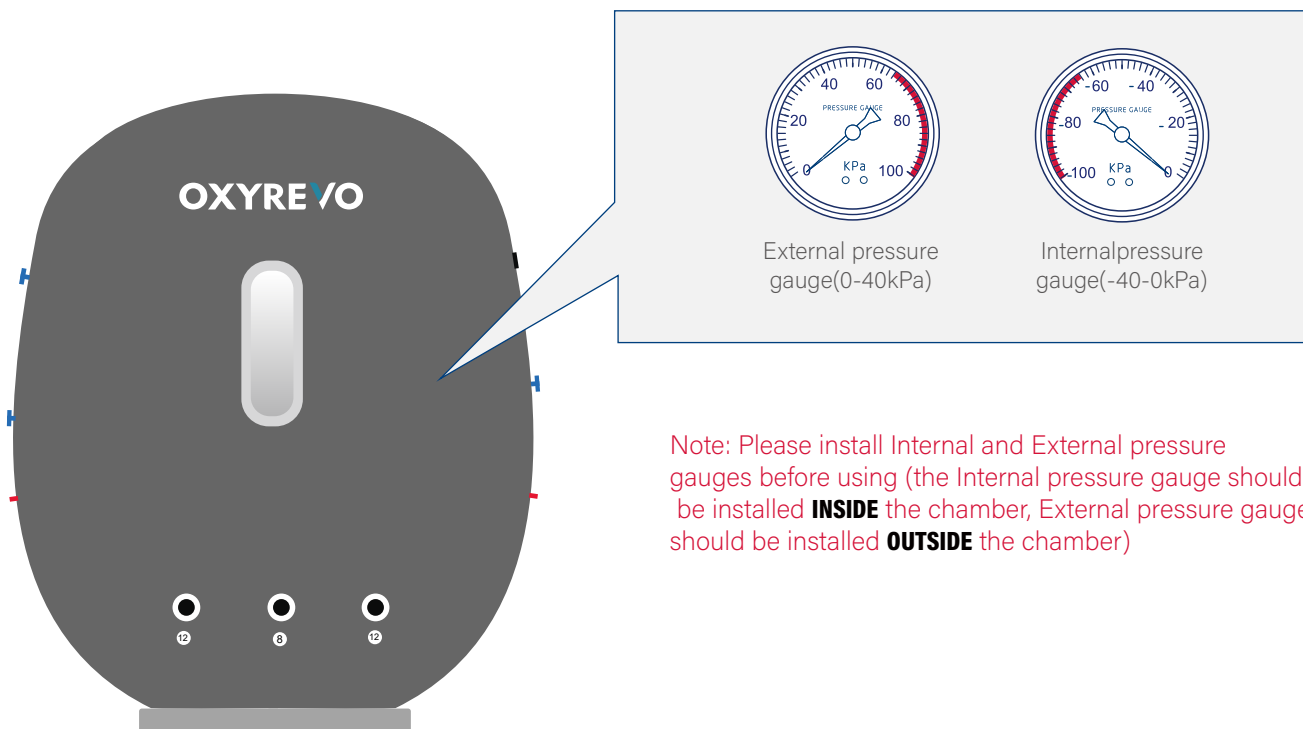

3. The Silencer is mounted to the Air Inlet Valve(Black) inside the chamber.  
The oxygen mask/headset is mounted to the Oxygen Inlet valve (Blue) inside the chamber (see below).

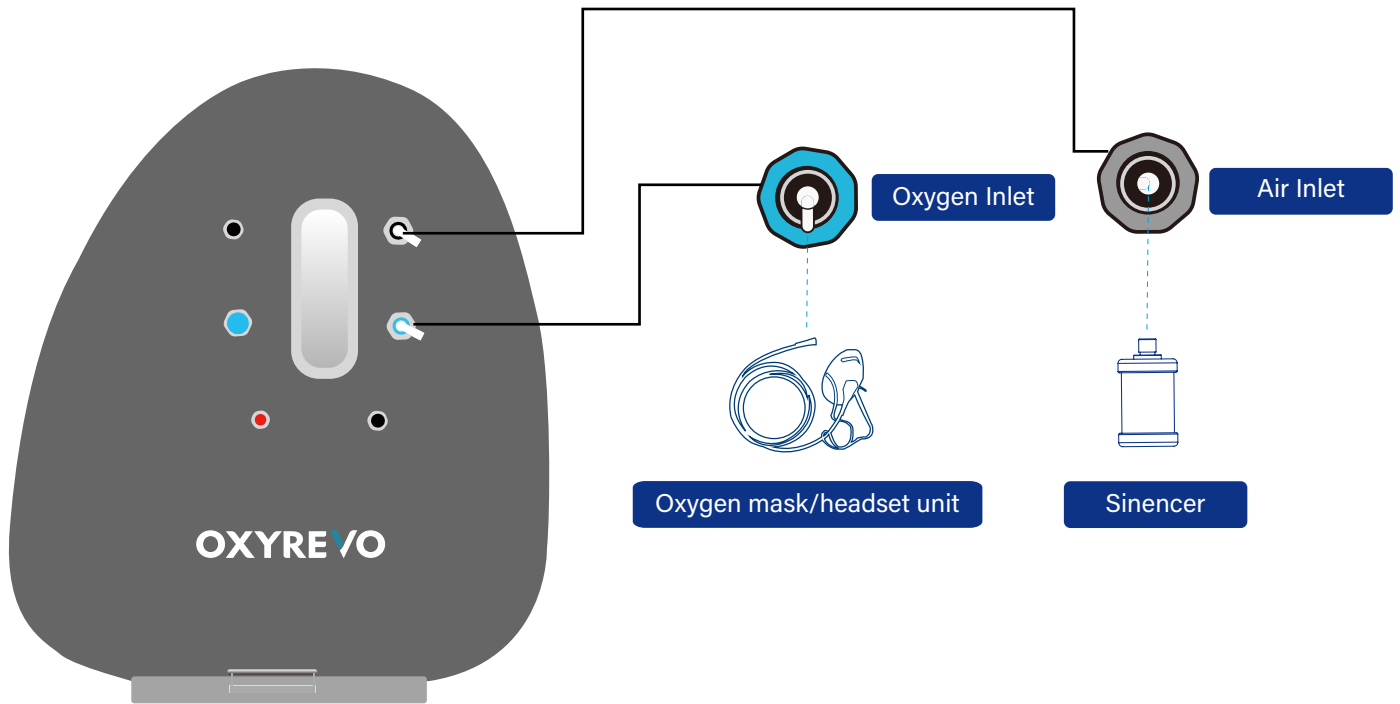

4. Connect Tubes to the Chamber.

- a. Connect the **Black** Air tube from Air port of ALL-IN-ONE machine to the Air valve(**Black**) in Chamber.  
b. Connect the **Blue** Oxygen tube from Oxygen port of ALL-IN-ONE machine to the Oxygen valve(**Blue**) in Chamber.

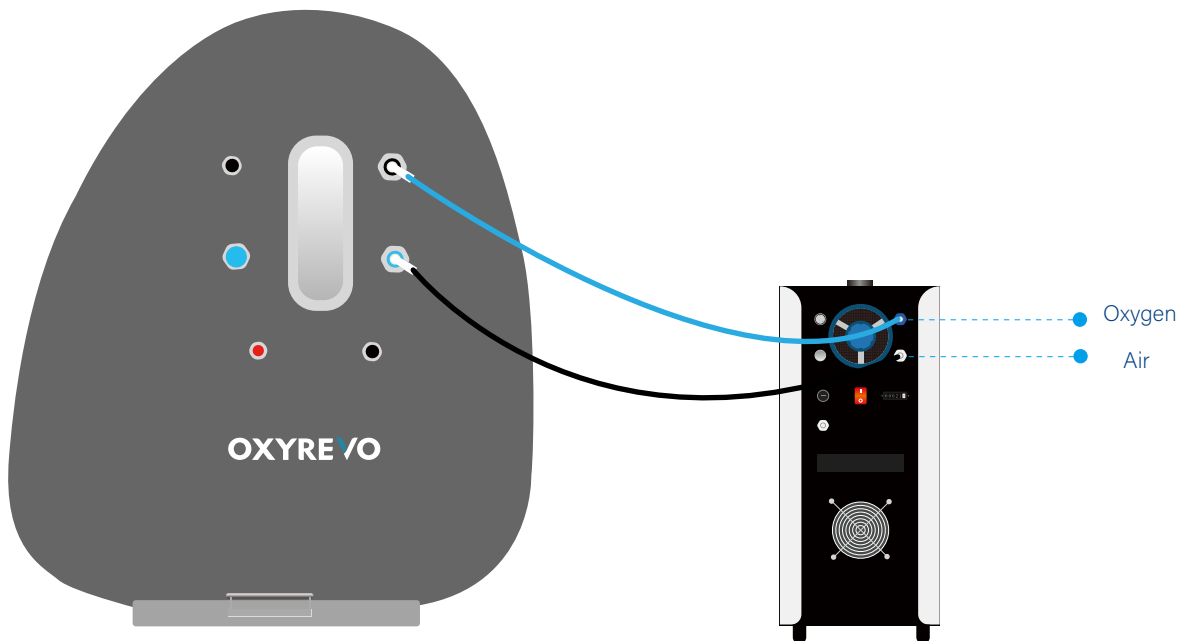

5. Unfold the plate to the ground.

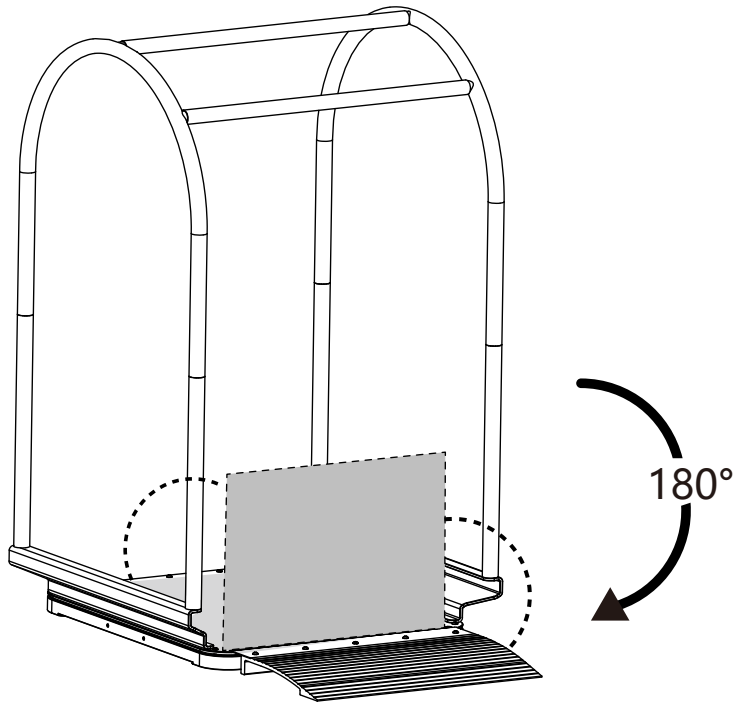

6. Pull the wheelchair to the chamber, fold the plate and lock it to frame rod.

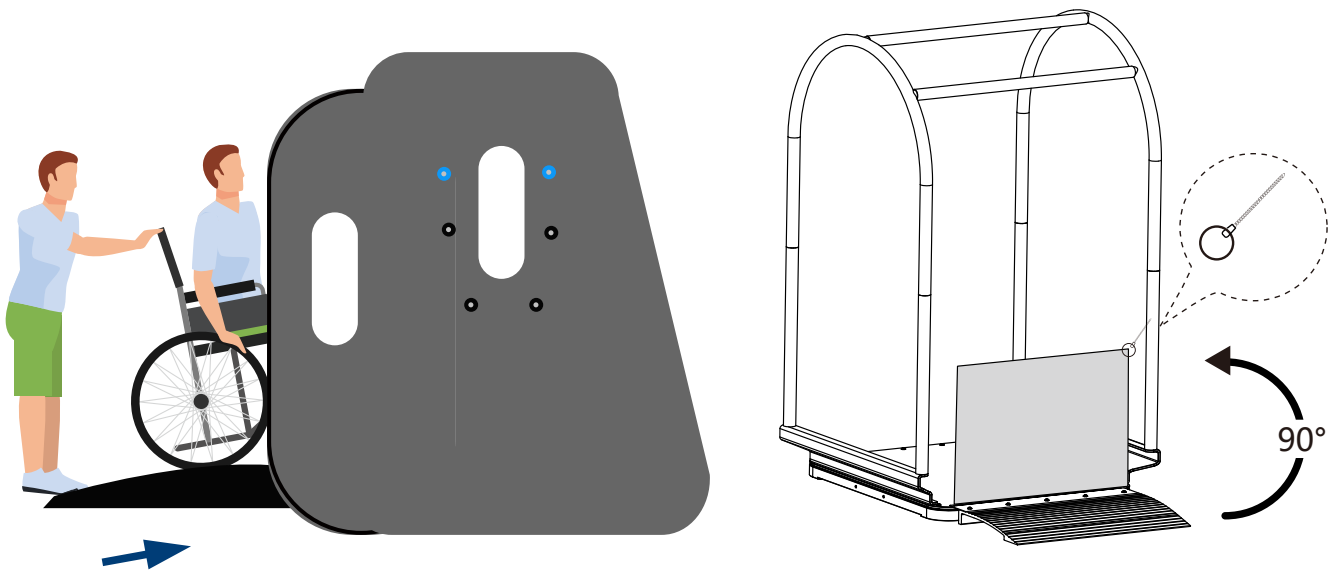

7. Close the Manual Pressure Deflate Valve.

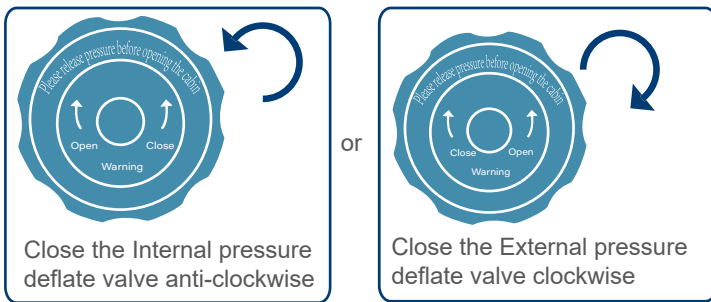

Pressure Deflate Valve can be operated both inside and outside of the chamber.

8. Close the inside and outside zippers

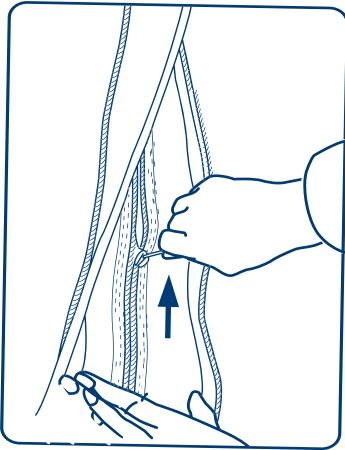

9. Put on oxygen headset or mask.

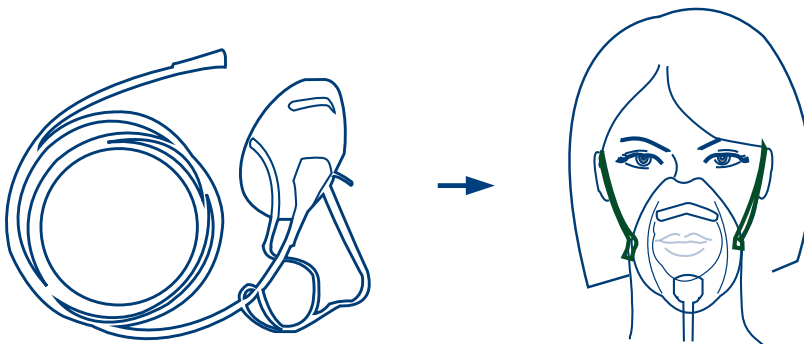

10. Turn on the operating unit all-in-one machine.

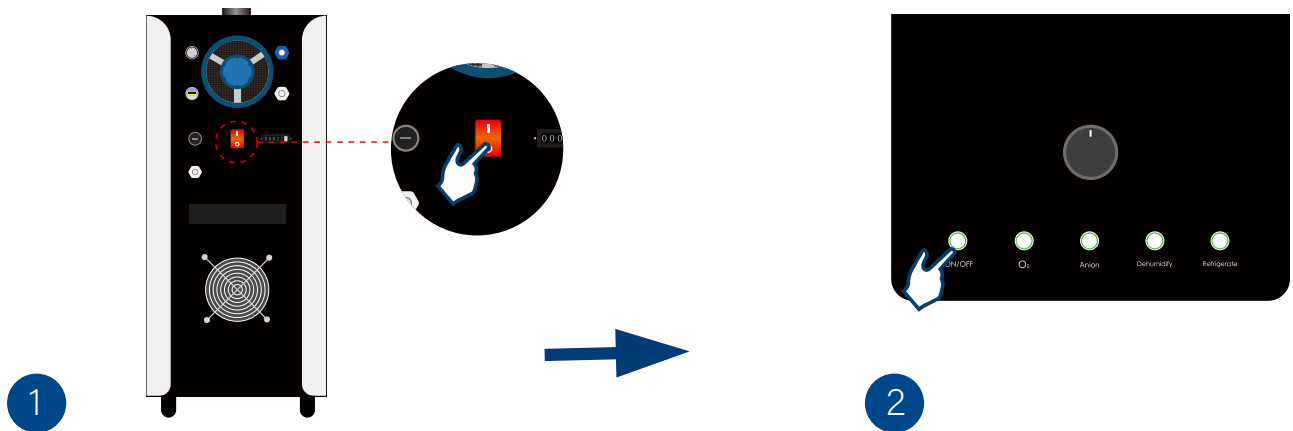

-Timer: Screw the button to set up the time you want to use for a session.  
(When the timer ends and the pointer returns to the OFF position, the timer buzzer will start to sound as a reminder, please turn the timer pointer to the ON position to turn it off.)

-ON/OFF Button: To control chamber's pressurization and decompression.

-O<sub>2</sub> Button: Turn on/off Oxygen supply.

-Anion Button: Turn on/off Anion supply, make the environment more fresh and clean.

-Dehumidify Button: Remove moisture.(You can turn on it each time when you use the chamber)

-Refrigerate Button: Cooling and reduce the temperature.(You can turn on it if you feel hot inside when use the chamber)

\*It is recommended to use your chamber at room temperature of 19-20 °C . Please turn on your room air conditioner when your room temperature is above 20 °C .

11. The recommended session time is 60-90 minutes per session.

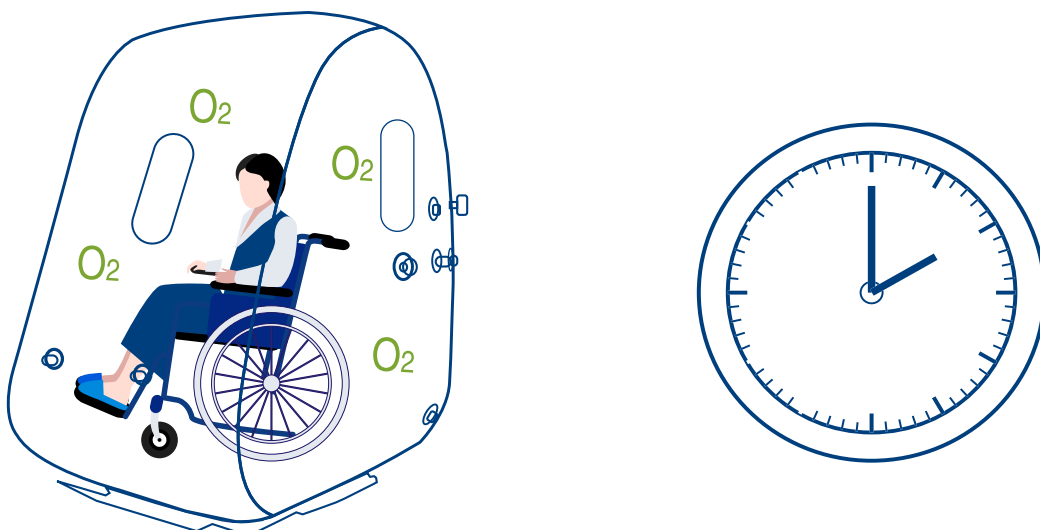

# Assembly and Operation

12. After the session, turn around the Manual Pressure Deflate Valve to deflate the chamber.

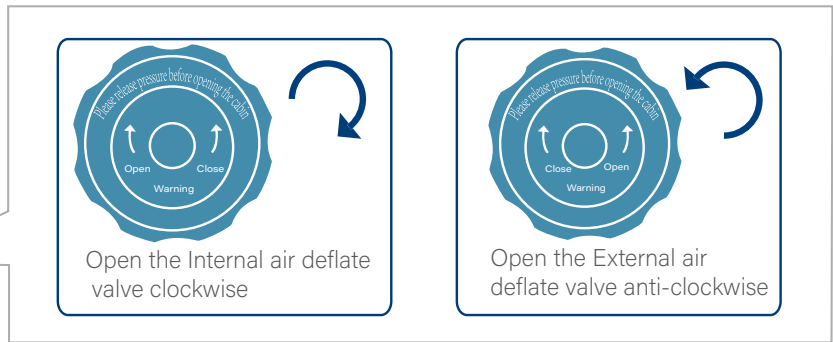

Note: Either valve could be used to deflate the chamber.

13. When the pressure gauge shows 0kPa, open the zippers and exit the chamber.

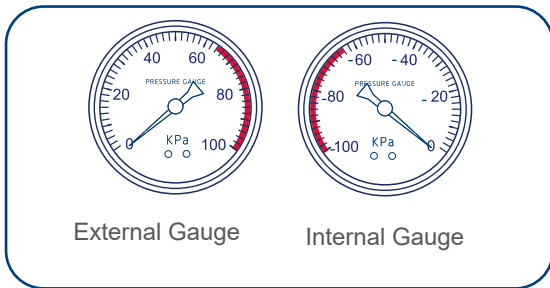

1. Gauges show 0kPa

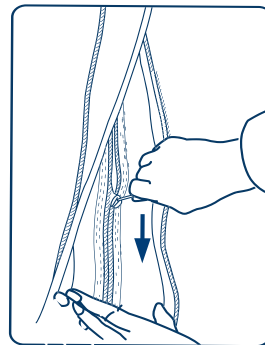

2. Open the inside and outside zippers

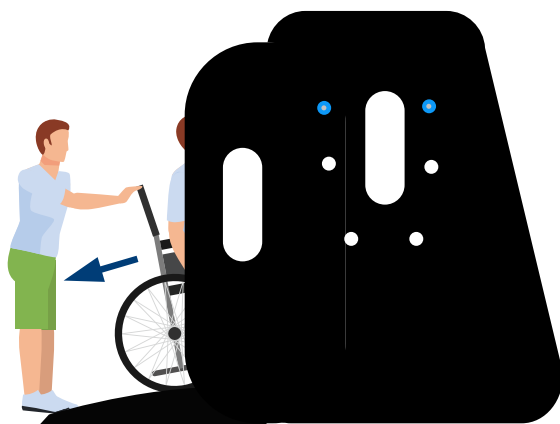

4. Exit from the chamber

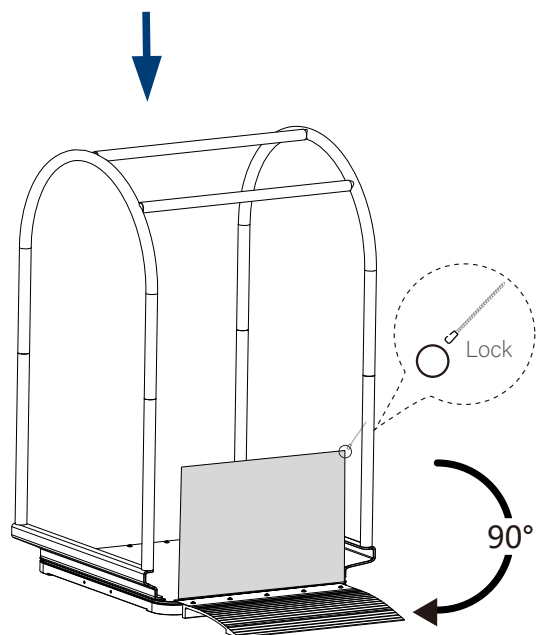

3. Loose the chair and Unfold the plate

14. After exiting the chamber, turn off the air-in-one machine unit.

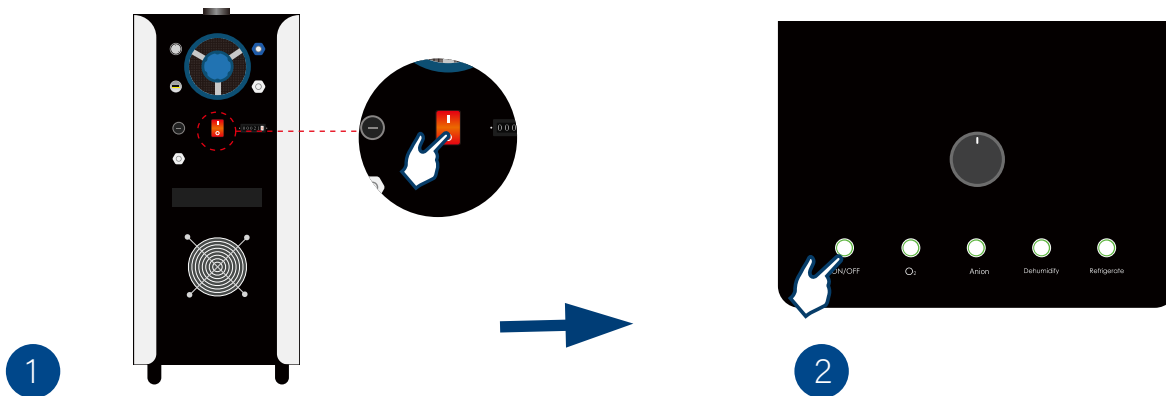

15. Tips for Water Container,

a. There is a water container in front of the all-in-one machine unit.

Please empty the contents before and after the session each time.

b. Take it off from the holder and empty the container after session finished and machine off.

\*The cooling system lowers the humidity inside of chamber for a more comfortable experience.

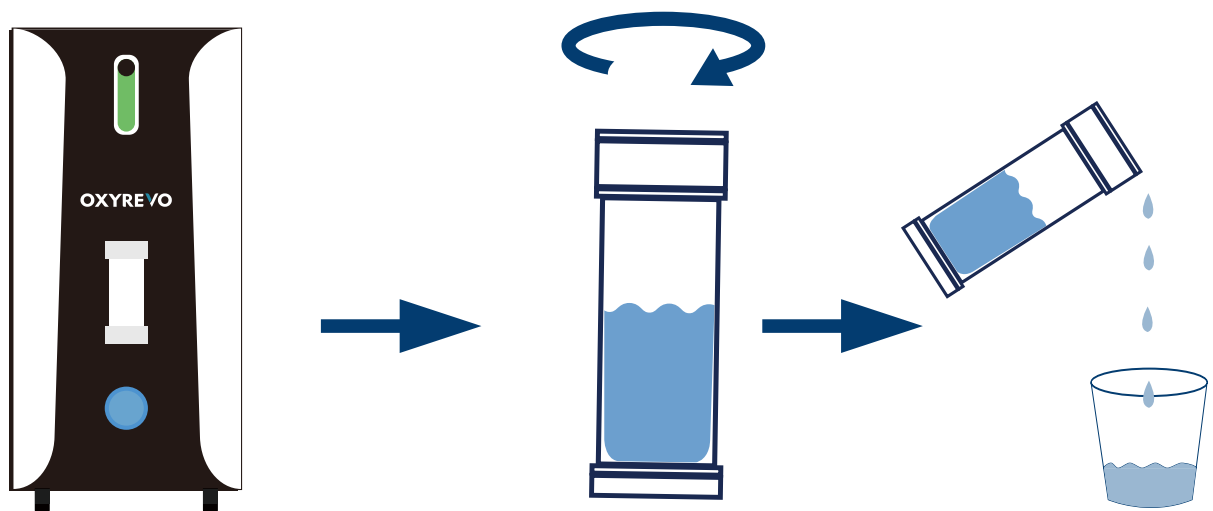

## 1. Chamber Maintenance and Cleaning

If necessary, clean the inside of the chamber with a damp/antibacterial cloth and run under pressure for 20 minutes until dry.



## 2. All-in-one Machine Operating Unit Maintenance and Cleaning

- Take off the filter containers and replace the filters (see below)
- Replace the activated carbon cotton filters every 6-12 months (depending on frequency of use).

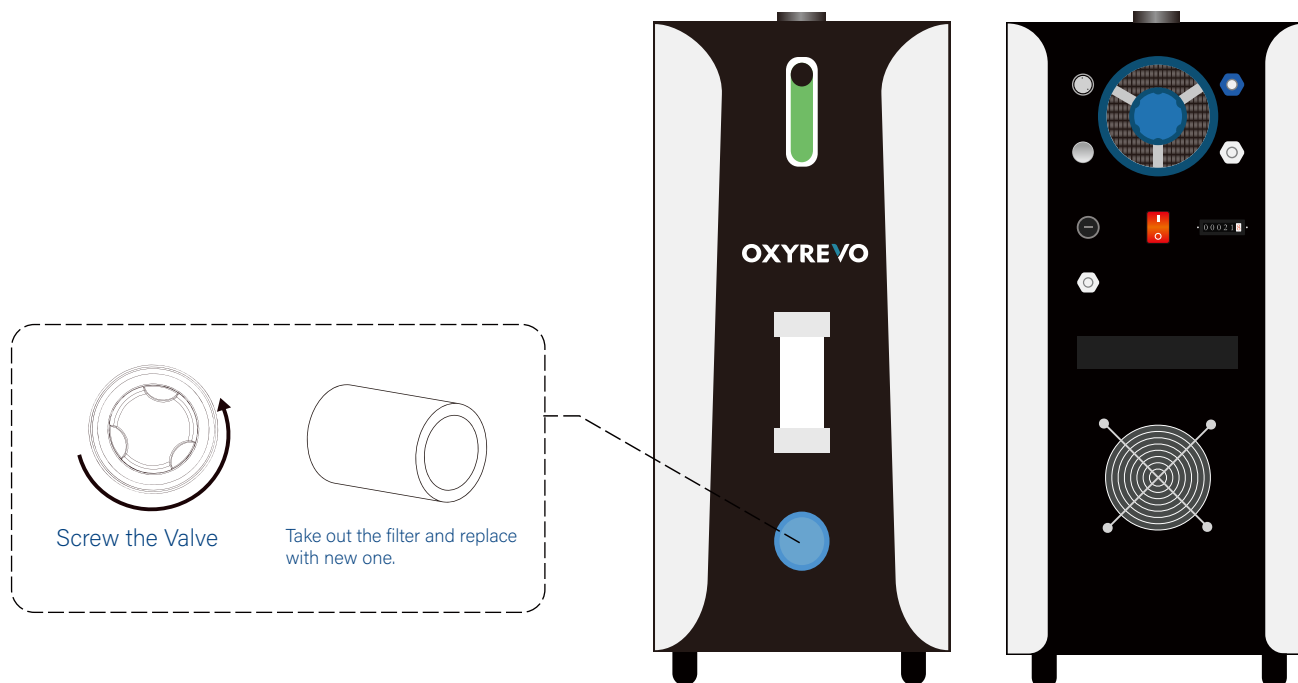

# Precautions



When using for the first time, please test the empty chamber first and observe whether the equipment is operating normally. If the equipment is running abnormally, please do not use it, and contact your dealer promptly.



When you exit the chamber, wait until the pressure gauge shows 0kPa before you open the inner and outer zippers. Do not force the zipper to open during use or when pressure relief is not complete.



In the event of an emergency or if the air deflate valve fails to operate properly, push the emergency relief valve from inside the chamber to relieve pressure. When the pressure is 0, pull the zipper and get out of chamber.



When you use the device for the first time, there may occur slight discomfort or pain in your ears. This is a normal phenomenon caused by pressure increase. The best way to relieve this is to pinch your nose shut and attempt to blow through your closed mouth.



Please place all the machines away from the wall in an open area for better heating spreading produced when machines running.

## 1. Clothing

- Wear the loose, comfortable clothes.
- You may bring electronic products/drinks into the chamber.
- Ladies should remove long socks (stockings). Please take off shoes before getting in.
- Shoes, jewelry, or any sharp objects that could damage the chamber should be removed.
- Disposable foot and hair covers may be used.
- To make the therapy experience more pleasant, you should get as comfortable as possible - that means taking care of restroom breaks and/or drinking water before getting into the chamber.
- The user should be advised to relax and breathe normally.

## 2. Chamber Pressurization

During the pressurization, some people may feel pain in the ears due to pressure on the tympanic membrane. This is normal and easily relieved. Chewing (gum) or repeated swallowing often equalizes this pressure. You can also pinch the nose shut and blow through closed mouth (as divers do). However, if the Eustachian tubes are blocked (due to a cold or allergy), the pressure cannot be equalized, and the user should terminate the session. The user can also slow the pressurization process by using the internal deflation pressure valve. When a session is finished, unscrew the air deflate valve to depressurize the chamber - the pressure will drop slowly from 40kPa to 0kPa - this depressurization process should take about 5-10 minutes. When the pressure gauges appear 0kPa, zippers can be opened, people can get out, and machines turned off.

## Warranty

All products come with 2 years of warranty from the date of delivery. During the warranty period, if there are any faulty materials and/or workmanship on the system (when properly operated), repair or replacement will be offered.



# OXYREVO

---

Hyperbaric Chamber

“Revolutionize Yourself Through Oxygen”

***THANK YOU!***

Website: [www.oxyrevo.com](http://www.oxyrevo.com)

Email: [info@oxyrevo.com](mailto:info@oxyrevo.com)