

CTN.FI

RECOVERY TECHNOLOGIES

OXYPRO™

VH4 Mild Hyperbaric Oxygen Chamber

USER MANUAL

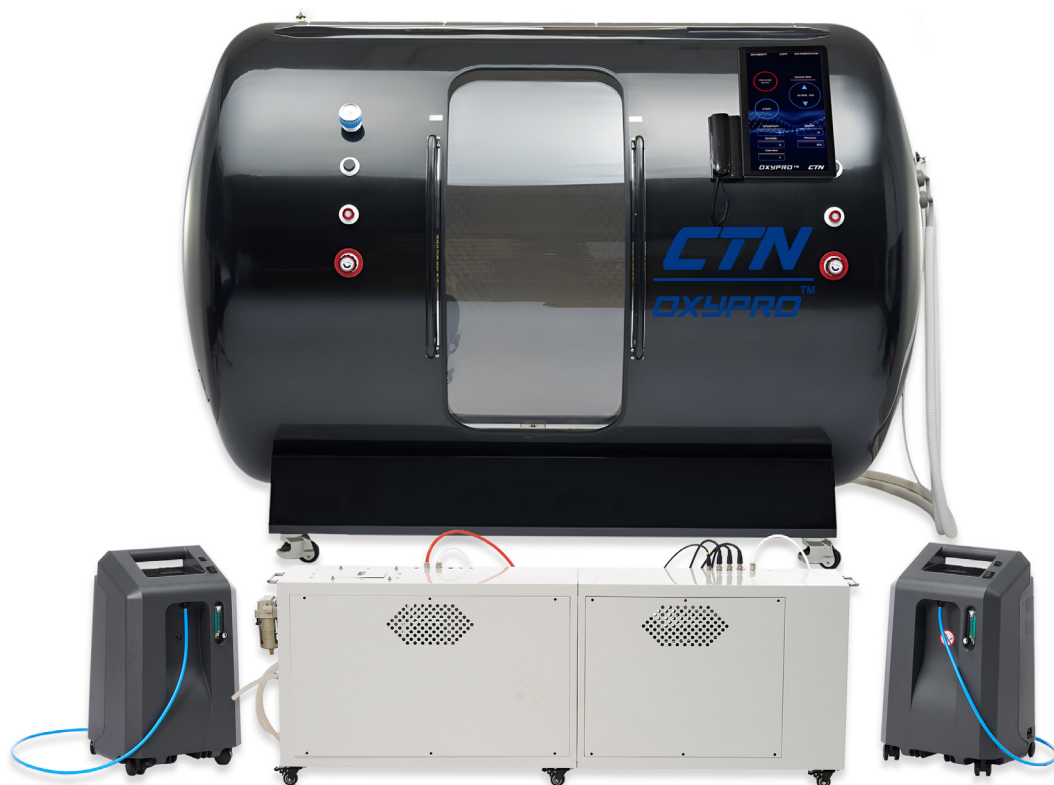

CTN.FI

10.2025

TABLE OF CONTENTS

PRECAUTIONS AND WARNINGS 3

CONTRAINDICATIONS 3

INTRODUCTION 4

WARRANTY INFORMATION 6

TECHNICAL SPECIFICATIONS 6

ENVIRONMENTAL REQUIREMENTS 6

COMPONENTS 7

CHAMBER: FRONT 8

CHAMBER: RIGHT SIDE/ LEFT SIDE 9

CHAMBER: BACK 10

CHAMBER: INSIDE 11

AIO UNIT 12

OXYGEN CONCENTRATOR 13

ASSEMBLY 13

INSTRUCTIONS FOR USE 15

IN CASE OF AN EMERGENCY 18

TRANSPORTATION 18

TROUBLESHOOTING 19

MAINTENANCE 20

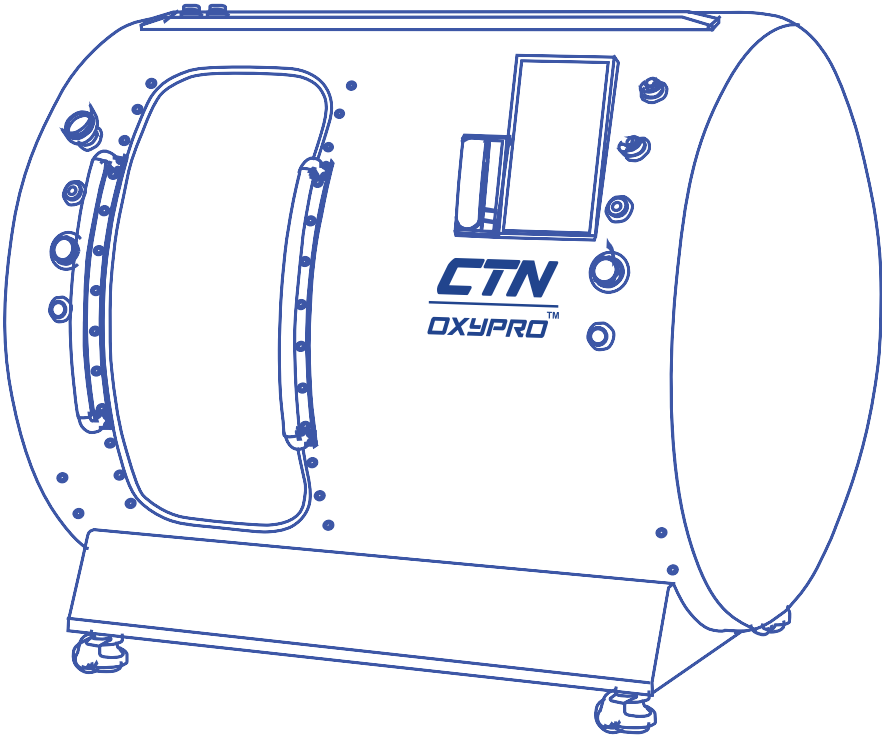

PRECAUTIONS AND WARNINGS

- Please read the instructions carefully before using the device.
- Use a dedicated power outlet for the cord. Make sure that the power plug is fully connected and not loose. Do not pull or twist the power cord with force.
- Do not use the device in wet or humid conditions. The indoor temperature should be maintained below 40°C and humidity below 80%.
- When cleaning or servicing the device, unplug the power wire.
- Stop using the device in case of any discomfort.
- If an abnormal smell occurs during use, turn off the power and pull out the plug.
- Do not attempt to disassemble the machine or make modifications.
- Children can only use this product under adult supervision.
- Do not place heavy objects on top of the machine.
- Do not touch electrical components with wet hands.
- Open flames and smoking near and in the chamber are prohibited. The possibility for sparks or open flames to happen in the room where the equipment is, must be eliminated.
- Regularly check the equipment and all connections for a safe and stable operation.

BEFORE FIRST USE:

- Fill the AC - see the Maintenance paragraph for instructions.
- Test an empty chamber first to make sure that the device is operating normally.
- If the equipment is operating abnormally, please do not use it and contact support.
- When using the device for the first time, people can feel discomfort in the ears, which is normal. Swallowing saliva or yawning can help adapt to the change in pressure, just as one would do during a plane takeoff. This is a normal phenomenon caused by increased pressure and should disappear once the pressure in the chamber has stabilised. After several times of use, this phenomenon will gradually disappear. If the user can not bear the pain, open the valves slowly to reduce the speed of pressurisation.

IN CASE OF AN EMERGENCY OR WHEN THE MANUAL PRESSURE REDUCING VALVE FAILS TO WORK NORMALLY:

- Please see the “In Case Of An Emergency” paragraph.

CONTRAINDICATIONS

Whenever unsure about any listed or other potential contraindications, please make sure that the client consults their doctor or seeks medical advice from the treating medical professional before administering any treatments.

Below are some of the possible contraindications:

- Infectious diseases and other serious illnesses
- Open cuts or wounds
- Pregnancy
- Intoxication
- Chest or lung diseases, a severe cold
- Use of pacemakers
- Use of heavy medications
- Untreated pneumothorax (pneumothorax)
- Chemotherapy drugs (adriamycin, cisplatin and bleomycin)
- Acute sinusitis (inflammation of the sinus cavity)
- Severe imbalanced asthma
- Claustrophobia

INTRODUCTION

TECHNICAL SUMMARY OF DEVICE FUNCTIONALITY

CTN OxyPro™ devices are non-medical mild pressure oxygen therapy (mHBOT) devices and are intended to enhance overall well-being and recovery. The devices are produced in both soft shell (PVC Vinyl) or steel construction. The devices are available in single-seater, 2/3 person and four-seater. The information presented here applies to all CTN OxyPro™ models, regardless of size or material of manufacture.

DESCRIPTION OF THE TREATMENT EVENT

During operation of the device, the internal pressure of the OxyPro™ is raised from normal sea surface air pressure to slightly less than 0.5 atmospheres (ATA), which corresponds to a depth of about 4-5 meters underwater. An increase in pressure below 0.5 ATA means that the OxyPro device is not classified as a pressure vessel according to applicable EU laws and regulations and is not subject to EU classification and inspection regulations for pressure vessels. The non-medical oxygen concentrator attached to the device increases the oxygen concentration inside the device from 21% to a maximum of 33% of normal indoor air. Due to this relatively modest increase in oxygen content, phones, laptops, etc. can be used in OxyPro during its use. Unlike medical high-pressure HBOT devices, which, in addition to higher pressure, breathe 100% pure medical oxygen, which together make the chamber fire sensitive.

SUMMARY OF THE USE OF THE DEVICE AND MARKETING OF TREATMENTS

Because OxyPro devices are not medical devices, medical claims should not be used in connection with them or when marketing treatments made with them. The devices are designed and intended for general well-being therapy, and although breathing oxygen-rich air in a low-pressure space has been proven to be beneficial for the client and refreshing and restorative in various ways, not enough medical studies have been conducted on mHBOT treatments. Due to the modest increase in pressure and oxygen levels compared to normal indoor air, CTN OxyPro™ is safe and easy to use. Nevertheless, in commercial use, it is recommended that staff be present and the client monitored throughout the treatment to ensure that the client's treatment experience is pleasant and that treatment can be interrupted immediately if the client so wishes.

The following page lists the most significant differences between HBOT and mHBOT devices: <https://hyperbarium.com/en/blog/different-hyperbaric-chambers>.

HBOT chambers	mHBOT chambers
Maximum working pressure	
3 ATA (tested up to 6 ATA)	1.4 ATA
Quality of inhaled oxygen	
Pure medical oxygen (100%)	Pure oxygen 24% - 90%
Personnel requirements for the operation of the device	
At least one clinical specialist with hyperbaric medicine skills + At least 2 hyperbaric operators, certified + medical assistant	mHBOT chambers do not require the presence of a certified user or medical professional
Materials of the chamber	
C-Steel hard shell, PED certified + acrylic PMMA, PVHO-1 and NFPA 99 certified	May have a hard or soft shell. There are no separately set standards for materials
Authorisation requirements	
HBOT chambers require medical permission	mHBOT chambers do not require medical permission
Classification and certification in the USA and EU	
Class IIb medical device	Not classified as a medical device
Fire extinguishing system	
HBOT chambers are equipped with an effective fire mist and water extinguishing system (HSFS) as a mandatory feature	There is no need for a fire extinguishing system in mHBOT chambers
Duration of treatment	
Most often from 120 to 150 minutes	60 - 90 minutes
Site requirements	
HBOT chambers can only be used in authorized hospitals or medical clinics	mHBOT devices are often used in beauty salons, gyms, various wellness clinics and home use
Medical examinations	
More than 300 published medical studies proving the effectiveness of treatment in HBOT chambers	The number of studies demonstrating the effectiveness of medical treatment in mHBOT devices is limited
Protection against voltage drops	
A system of protection against voltage fluctuations or drops in electrical voltage is mandatory	mHBOT chambers do not have mandatory protection against voltage fluctuations or drops
Medical recognition	
The FDA approved 14 different diseases, the European Committee of Hyperbaric Medicine (ECHM) approved more than 30 different diseases, the Society of Hyperbaric and Underwater Medicine (UHMS) approved 14 different diseases, the Society approved the European Baromedical Association (EUBS)	The FDA and the Underwater and Hyperbaric Medicine Society (UHMS) recommend one disease: acute altitude sickness (AMS) and its associated mild symptoms. It has not been approved or recommended by the European Committee of Hyperbaric Medicine (ECHM). It is not approved or recommended by the European Baromedical Association (EUBS)

Source: <https://hyperbarium.com/en/blog/different-hyperbaric-chambers>

WARRANTY INFORMATION

Void of factory warranty. A 36 months limited manufacturers factory warranty is applied to each sold CTN device, and is valid from the date of delivery. The term is 36 months for materials and manufacturing defects, and 12 months for computers and electronic components. Each device has its own specific requirements for the ambient conditions of the space it will be installed in or used. These include but are not limited to square meters, cubic meters, maximum ambient temperature and humidity, power feed etc. Non-compliance with the safety information, installation and operating instructions or specifications and ambient conditions of the space the device is used, can lead to danger for people, the environment, endanger the device and its functions, and lead to the loss of claims for damages of any kind.

TECHNICAL SPECIFICATIONS





Chamber:	OxyPro™ VH4
Pressure:	1.5 ATA
Material:	Stainless Steel
Size:	L 2580 x W 1700 x H 1832 (mm)
Weight:	600 KG
Colors:	White/ grey exterior, white interior.
Compressor:	
Size:	L 1720 x W 350 x H 650 (mm)
Flow of air:	140L/min
Weight:	95 KG
Power:	1250 W, 110 V/60 Hz, 220 V/50 Hz
Flow of oxygen:	20L / min via external O2 unit
Features:	Functions as an air compressor. Air conditioner included as an extra unit.
Concentrator:	External unit, 2 x 10L concentrators
Size	L 350 x W 320 x H570 (mm)
Weight	25 kg/ unit
Power	480 W/ unit, 110 V/60 Hz, 220 V/50 Hz
Additional info:	Can accommodate up to 4 people Controllable internally and externally.



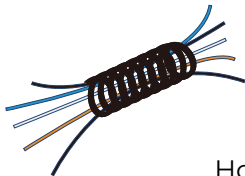
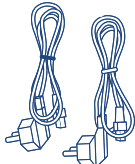
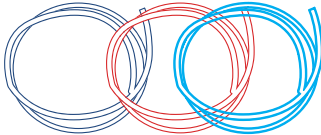
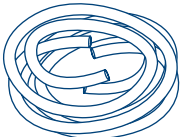

ENVIRONMENTAL REQUIREMENTS

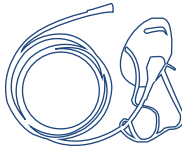
It is essential that the environment where the device is being operated, is as clean as possible. The room should be well ventilated, free of dust and corrosive gases. The relative humidity needs to be <80%, ambient temperature range is 10°C – 40°C, atmospheric pressure 86 kpa – 106 kPa. The device should be placed away from any other equipment that emits strong electromagnetic fields. It is forbidden to smoke, light a spark or a flame inside and outside of the chamber, and the room where the device is placed. The chamber with its additional units should not be placed in direct sunlight. In case the temperature can drop below 5°C during storage and transport, allow the equipment to warm up to indoor temperatures (approximately 4 hours), before powering on any of the devices. Ensure that all parts of the equipment have at least 20 cm of free space around it. Do not place the equipment near heat sources.

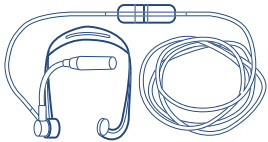
COMPONENTS

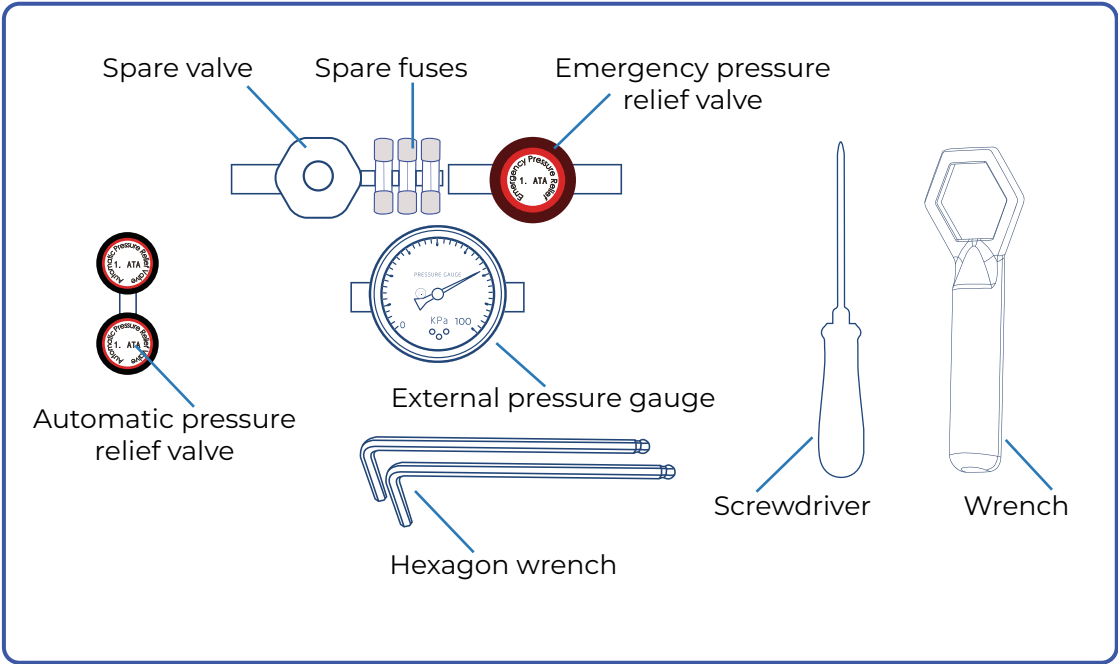
 <p>Hoses</p>	 <p>Power cables</p>	 <p>Air, door and oxygen tubes</p>
 <p>Spare hoses</p>	 <p>Activated carbon filter</p>	 <p>Oxygen mask</p>
 <p>Bucket</p>	 <p>Silencer</p>	 <p>Oxygen breathing headset</p>

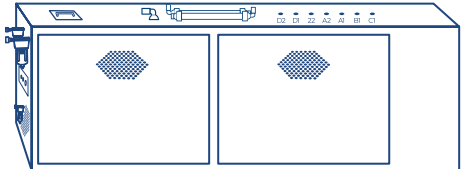

		
<p>Oxygen concentrator 1</p>	<p>Oxygen concentrator 2</p>	<p>All-In-One compressor unit</p>

CHAMBER: FRONT

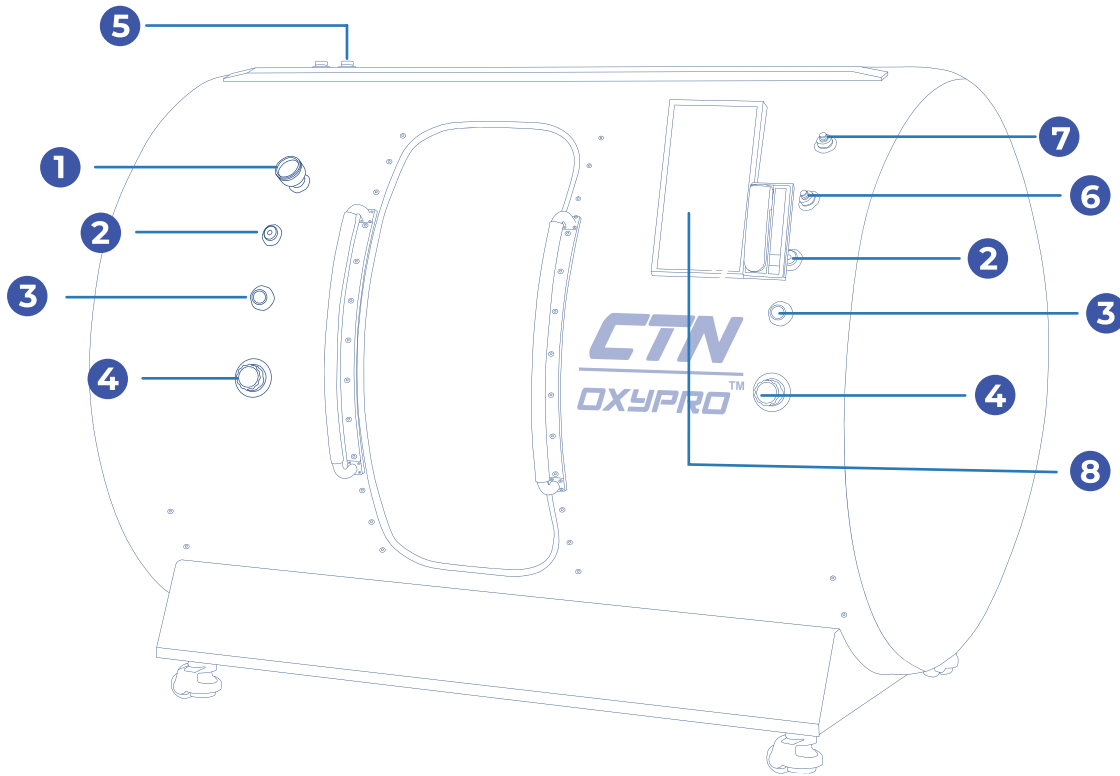

1.	External pressure gauge
2.	Spare valve
3.	Emergency relief valve
4.	Pressure valve
5.	LED
6.	Internal pressure gauge
7.	Control panel wire
8.	Control panel + intercom

CHAMBER: RIGHT SIDE/ LEFT SIDE

RIGHT

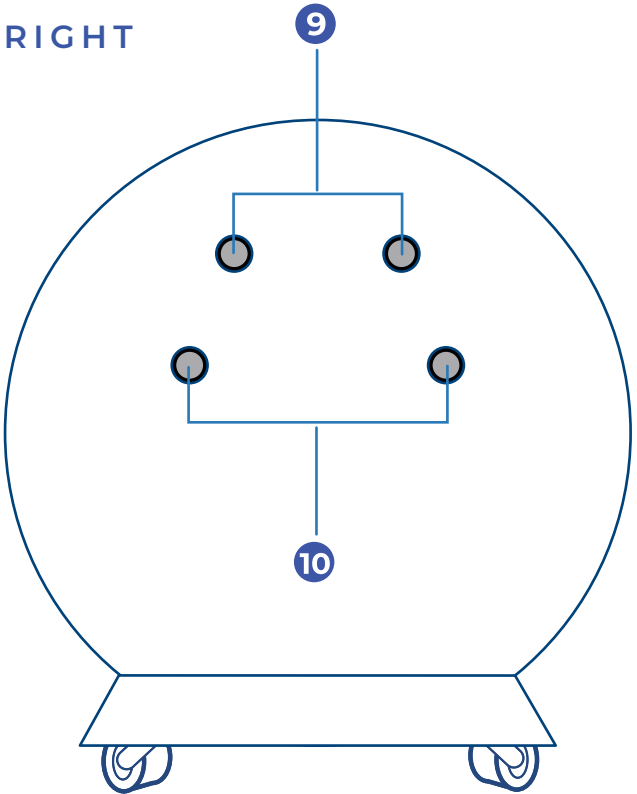

LEFT

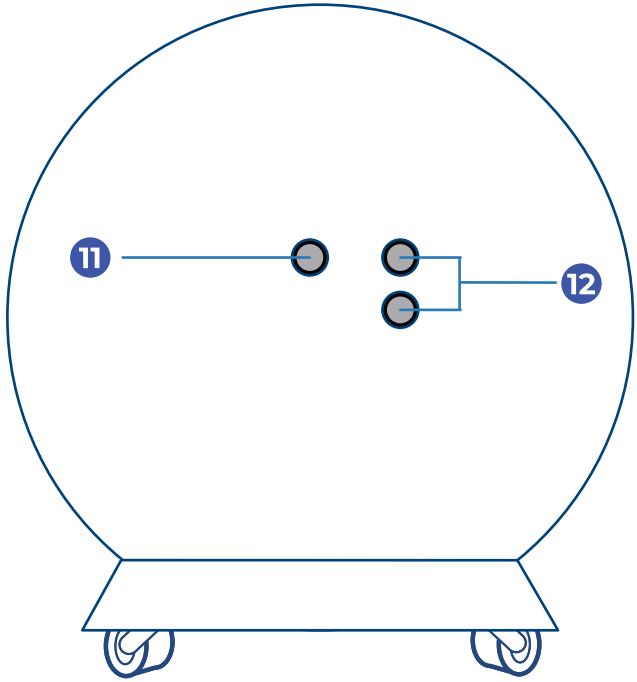

9.	Automatic pressure relief valve
10.	Spare valve
11.	AC drain
12.	AC inlet & outlet

CHAMBER: BACK

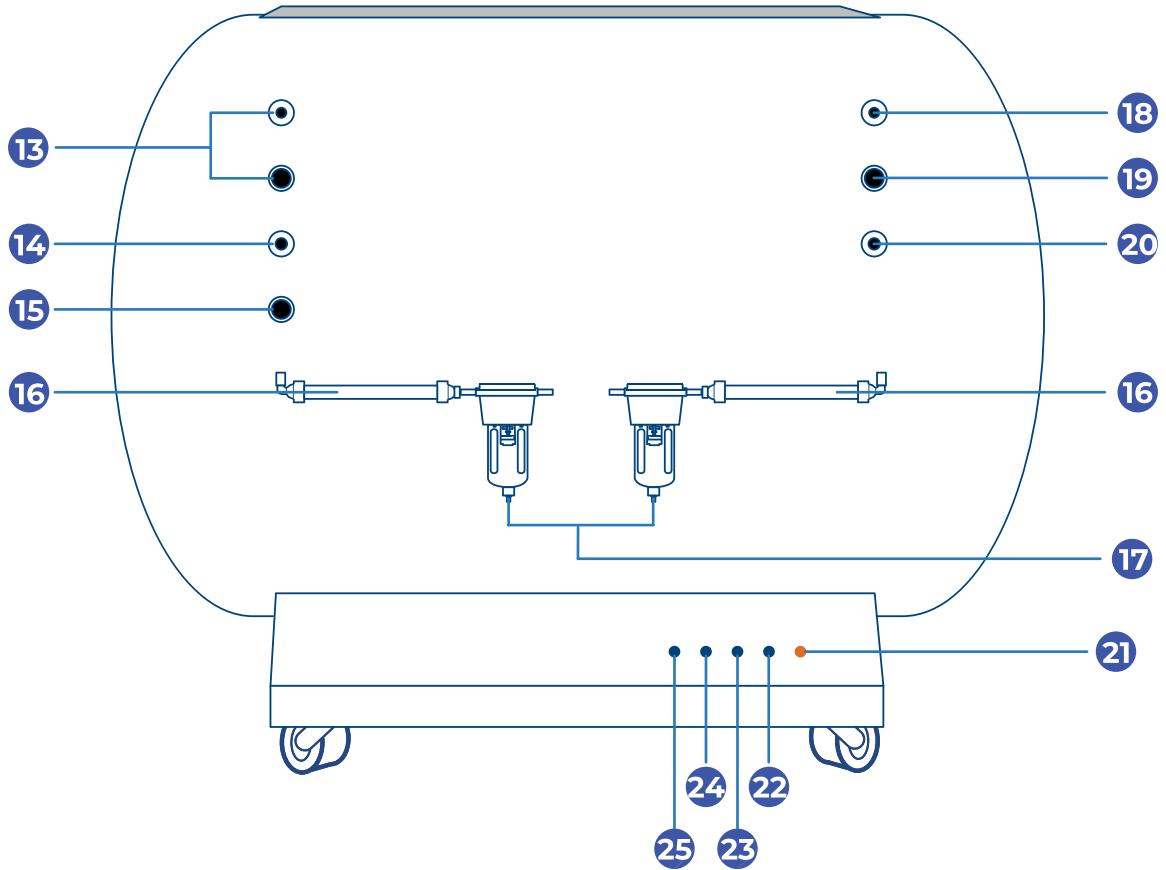

13.	Spare valves	20.	Oxygen inlet connector
14.	Air inlet connector	21.	Cabin door connector
15.	Oxygen inlet connector	22.	B1 Internal power
16.	Air filter	23.	A1 Internal controller
17.	Water collector	24.	A2 External controller
18.	Sensor	25.	TV, AC power
19.	Air inlet connector		

CHAMBER: INSIDE

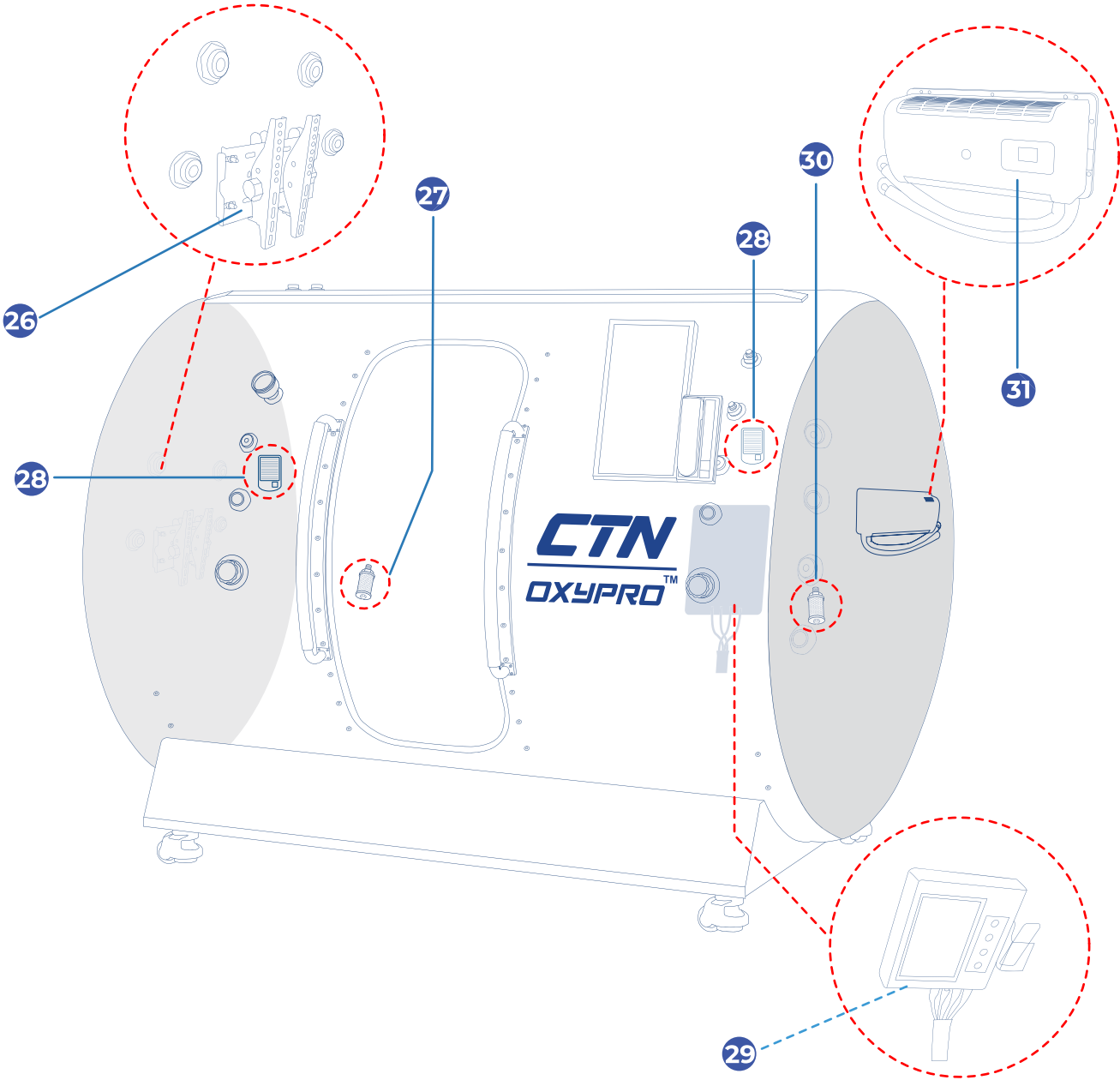

- | | |
|-----|-------------------|
| 26. | TV stand |
| 27. | Silencer |
| 28. | Intercom system |
| 29. | Internal controls |
| 30. | Silencer |
| 31. | Air conditioner |

AIO UNIT

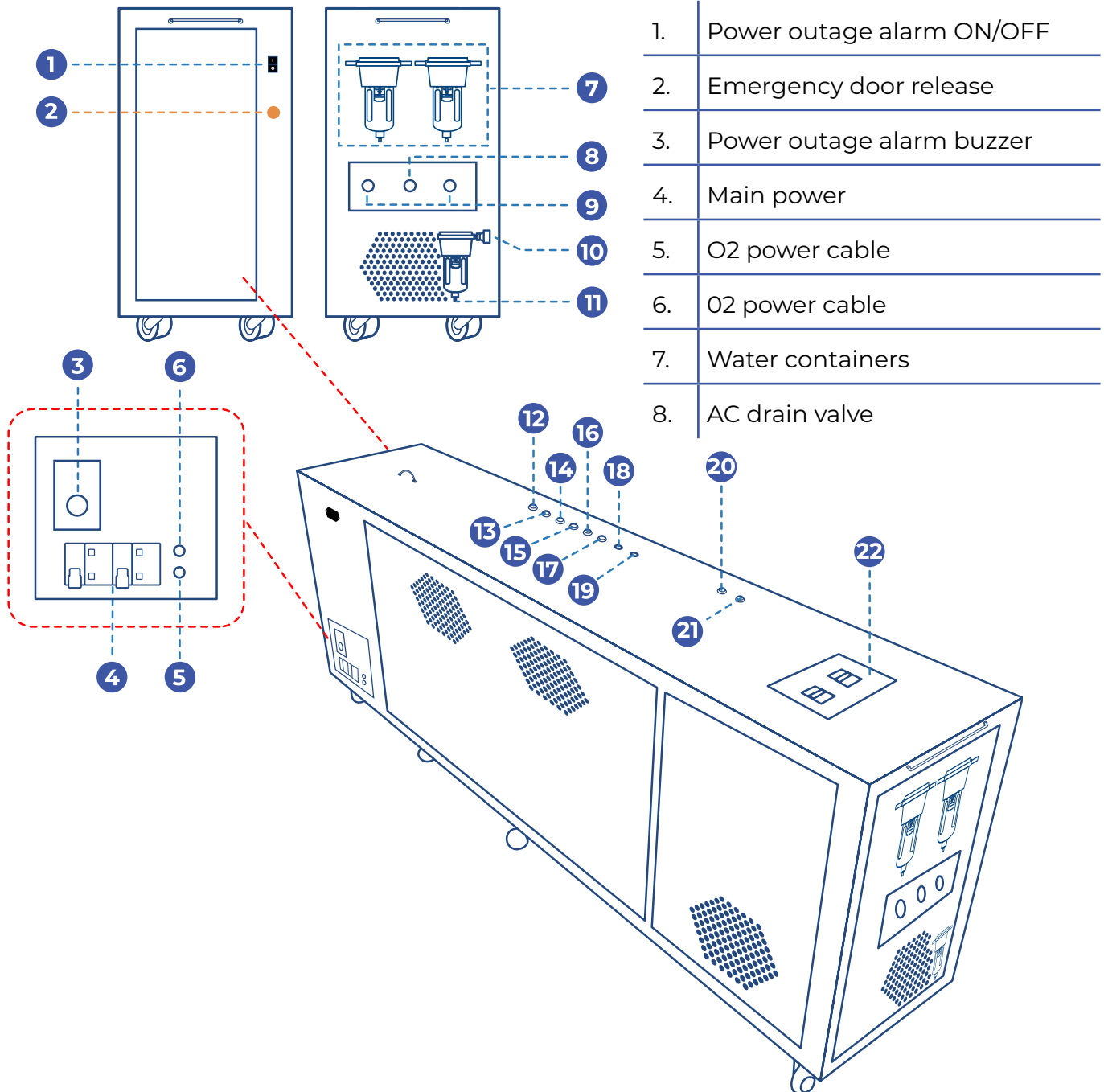

- | | |
|----|---------------------------|
| 1. | Power outage alarm ON/OFF |
| 2. | Emergency door release |
| 3. | Power outage alarm buzzer |
| 4. | Main power |
| 5. | O2 power cable |
| 6. | O2 power cable |
| 7. | Water containers |
| 8. | AC drain valve |

9.	AC inlet & outlet	16.	A2 External main controller
10.	Drain outlet	17.	22 Internal fan & TV power supplies
11.	AC condensation outlet	18.	D1 Oxygen concentrator
12.	Air connector	19.	D2 Oxygen concentrator
13.	C1 Sensor wire	20.	Door connector
14.	B1 Internal controller power	21.	Air connector
15.	A1 Internal main controller	22.	AC water filling port

OXYGEN CONCENTRATOR

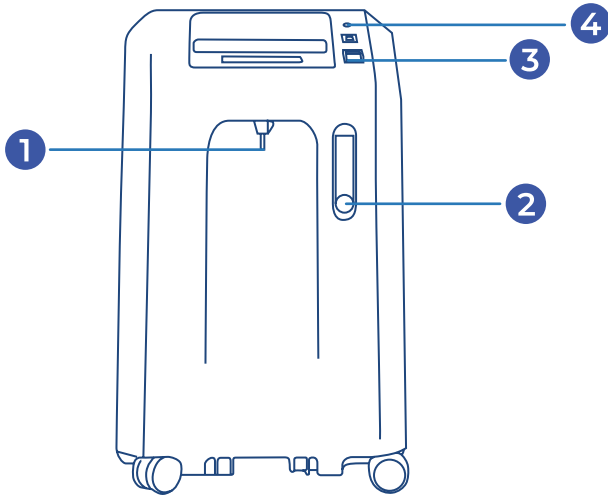

- | | |
|----|----------------------|
| 1. | Oxygen outlet |
| 2. | Oxygen flow adjuster |
| 3. | Power |
| 4. | AIO unit connector |

ASSEMBLY

1. Install the internal and external pressure gauges.
The external gauge is blue and the internal gauge is black.

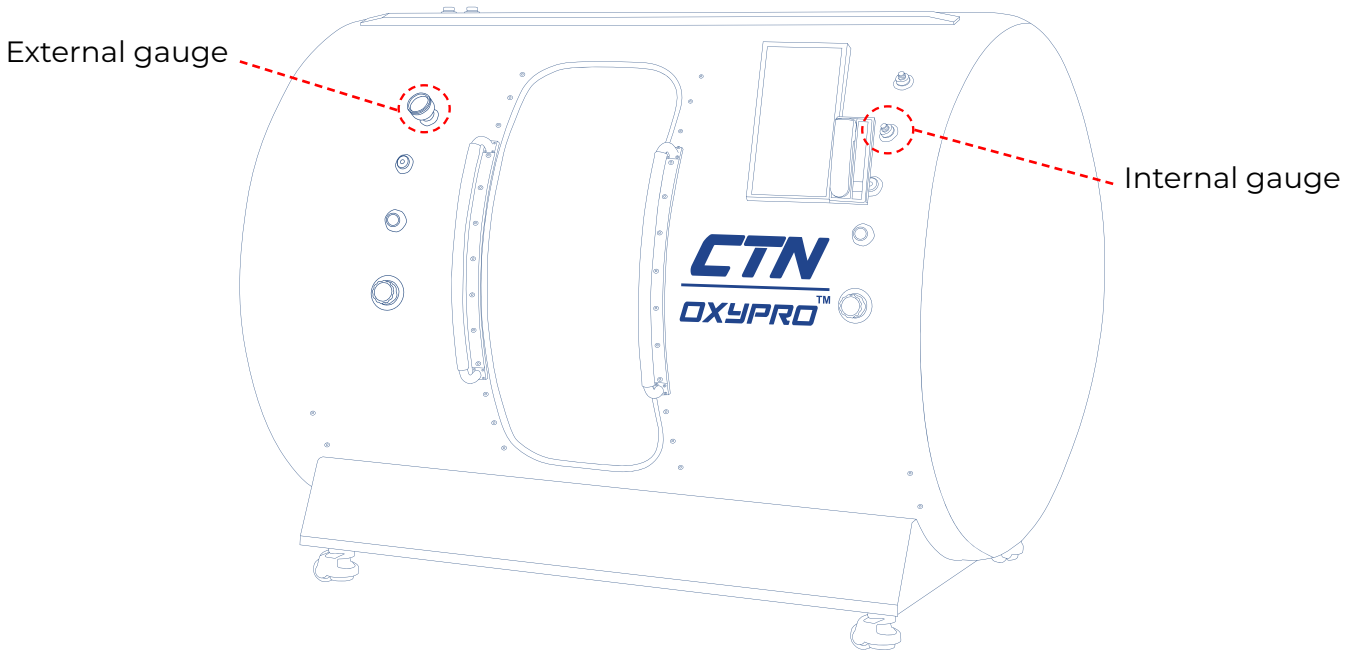

2. Follow the labelling on the scheme as well as the hoses and wires to complete the assembly.

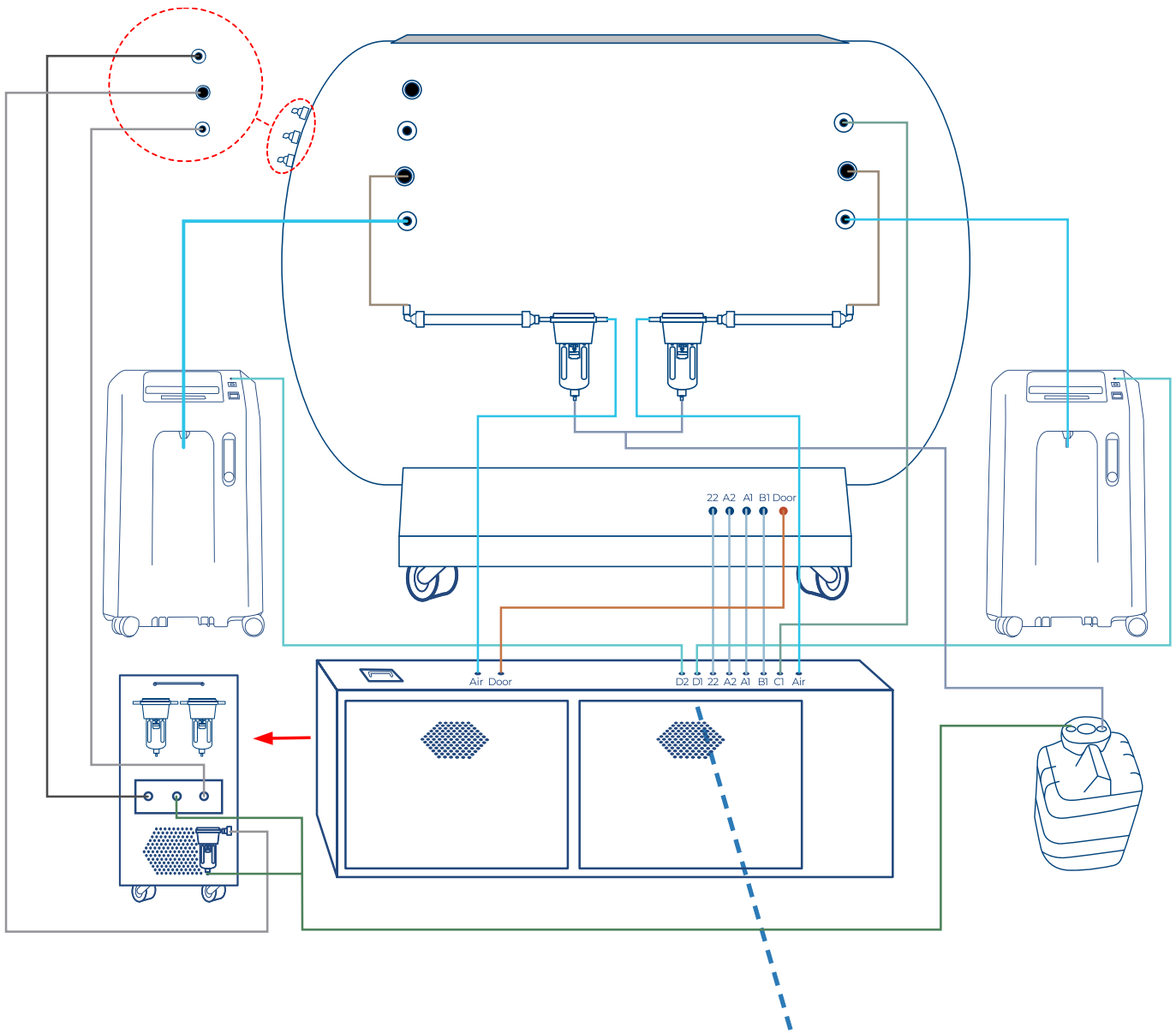

3. Ensure all components have been installed and that all wires and hoses are tight before powering on the unit.

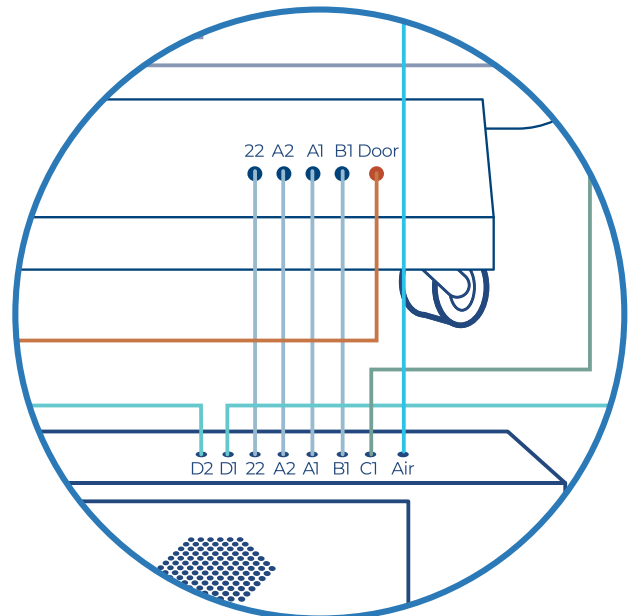

INSTRUCTIONS FOR USE

Loose and comfortable clothes are recommended for the session. Avoid silk stockings, jewelry and any sharp objects.

1. Power on the AIO unit by flipping up the two blue switches.

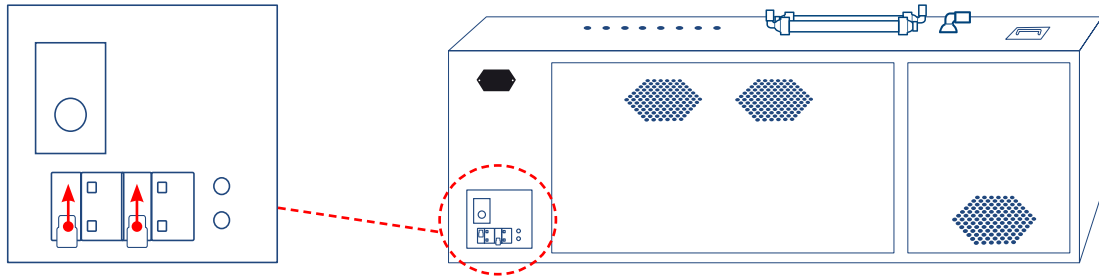

2. Power on the two oxygen concentrators and set the oxygen flow to 10 liters/ min. Turn the flow meter knob counterclockwise to increase the flow rate.

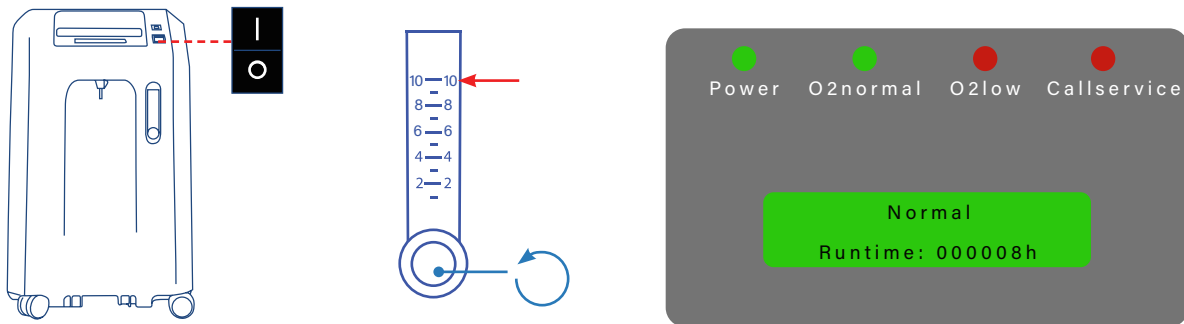

NOTE: In an instance where the O2Low flashes with an alarm, the oxygen concentration is too low. Stop using the equipment and contact support. In an instance where the Callservice light flashes with an alarm, there may be a power failure or a compressor failure. Stop using the equipment immediately and contact support.

3. Connect the oxygen headset or mask to one of the indicated ports for clients to wear during the session. Up to two headsets or masks can be connected to a single port with the help of a T-joint.

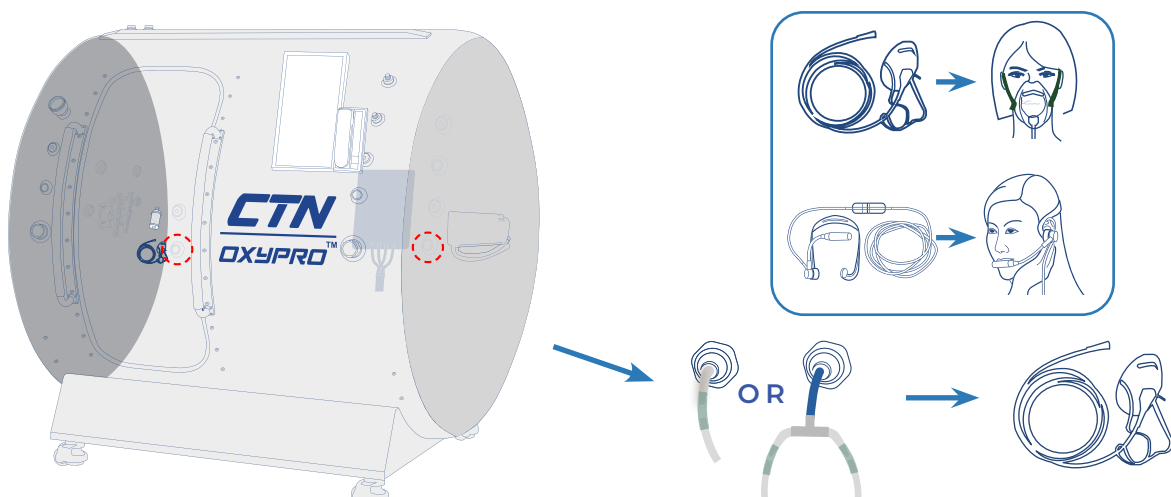

4. Open the chamber and enter / have the client enter. Close the door. A beeping sound will indicate that the door is fully closed.

5. Turn on the DEHUMIDIFY, LIGHT AND AIR PURIFICATION FUNCTIONS.

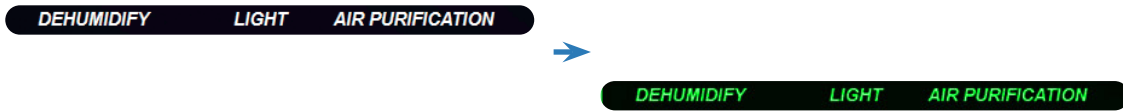

6. On the internal or external screen, set the session time (60 minutes, for example), then tap on the START icon.



7. The internal remote has buttons for turning on the internal TV, powering on the air conditioner, turning on the main internal light and USB hub functionality.

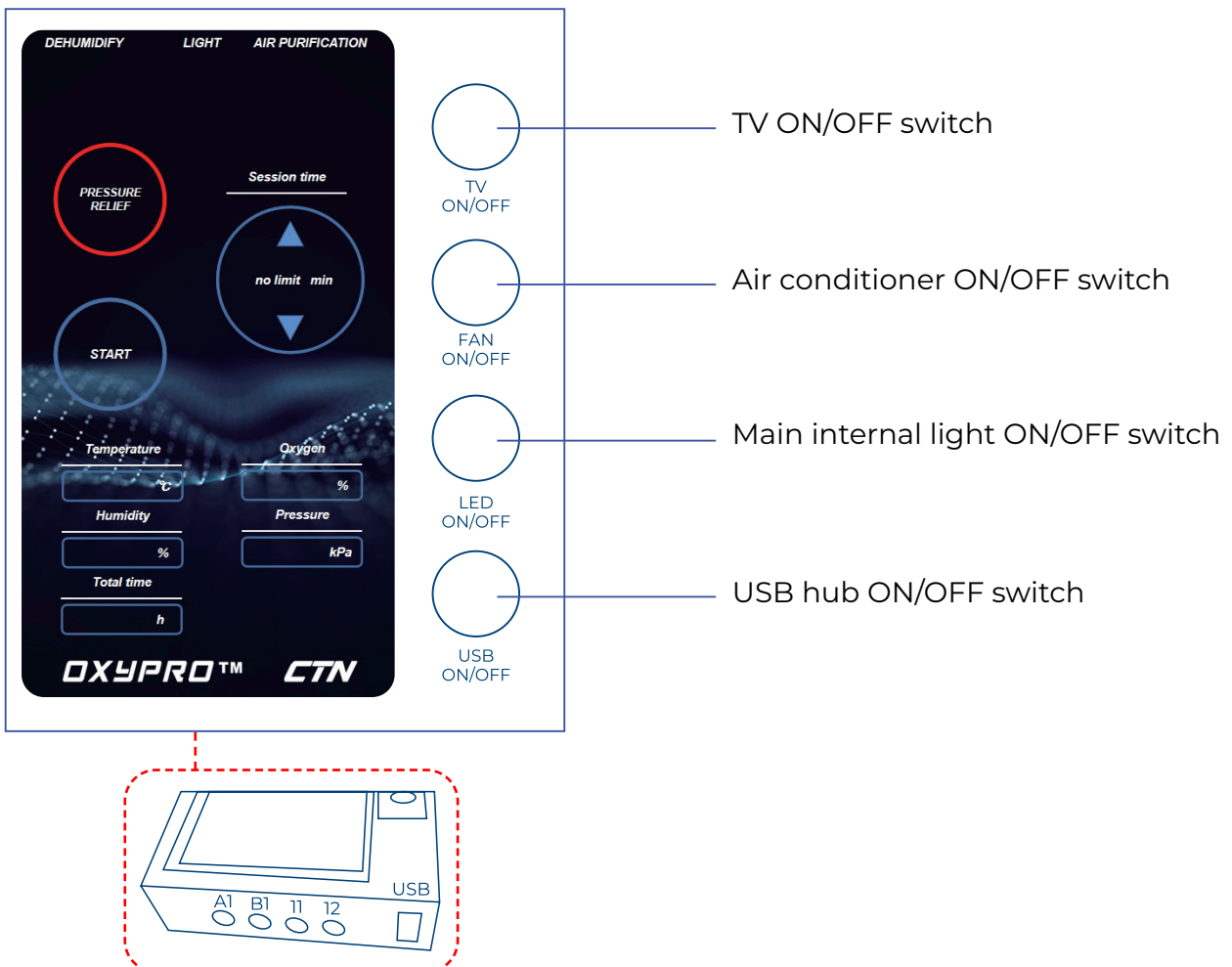

8. Close the two pressure valves on the chamber and start enjoying the session. It will take about 10 minutes for the chamber to pressurise. Open the valves up a little bit if the pressurisation is too quick and the users report pain in their ears.

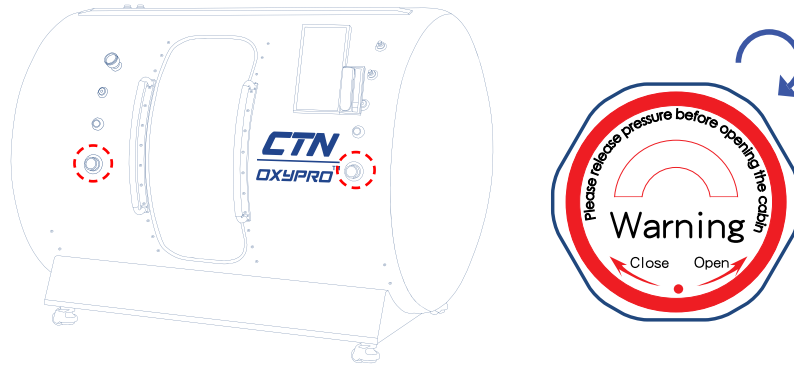

9. To use the air conditioner, ensure that the FAN ON/OFF button on the internal remote is switched on, then turn on the AC from the AC control remote. The temperature and wind speed can also be adjusted on the AC panel.

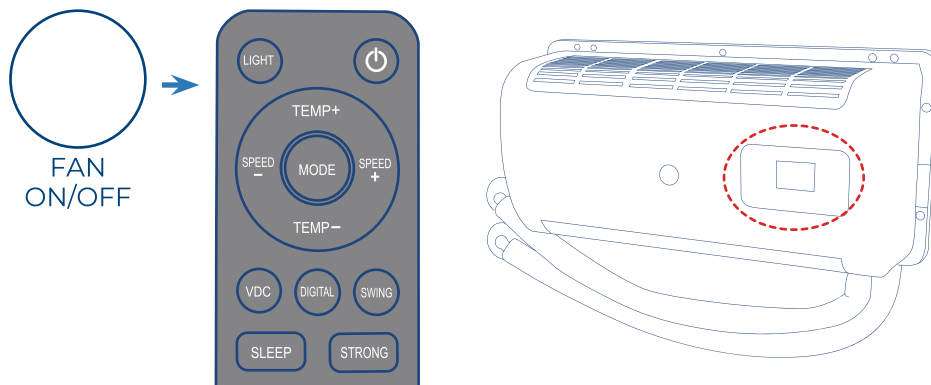

10. Intercom conversations can be initiated by pressing the button next to the internal or external intercom remote.



11. To finish the session, tap on the pressure relief button. The ring around the button will turn red. Open the two pressure valves slowly and wait until the pressure gauge shows 0 kPa. The chamber door will then drop automatically and can be opened.

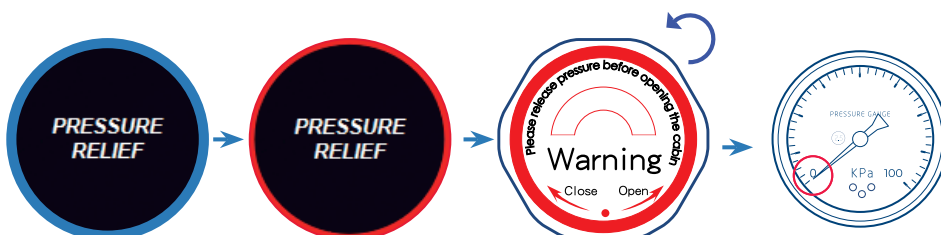

12. Do not leave the air conditioner on overnight. Turn off the AC unit from the internal remote panel FAN ON/OFF button.

IN CASE OF AN EMERGENCY

The AIO unit is equipped with a power outage alarm system. In case there is a power outage, an alarm sound will play. Please note, that the power outage alarm system must be armed (when part nr 1. on the AIO unit – the power outage alarm is turned off, the power outage alarm function is disabled.)

When the chamber suddenly loses power, open the pressure relief valves located on both sides of the chamber or press the emergency relief valve. Once the pressure goes to 0 kPa, the chamber door will automatically drop and the door can be opened. In an instance where the chamber door fails to drop, the interior of the chamber and AIO unit are equipped with an additional emergency door release button, which can release the air from the door's pneumatic system and allow the door to open. The button needs to be pressed down for 10-30 seconds.

It takes approximately 10 minutes to depressurise the chamber by opening the two manual pressure relief valves. The emergency pressure relief valve can release the pressure in about 2 minutes.

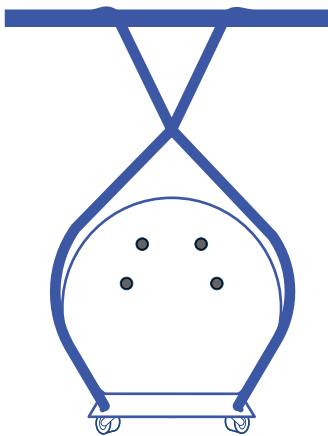

TRANSPORTATION

As the chamber has wiring and tubes at the bottom that can be damaged, the recommended way of moving the device is by lifting it with straps.

TROUBLESHOOTING

If your device does not function properly, please refer to the troubleshooting table below. If the problem can not be resolved, please contact our support team at service@ctn.fi. Do not attempt to further diagnose and repair the equipment by yourself.

Description	Possible cause	What to do?
Slow chamber pressurization	<ol style="list-style-type: none"> 1. The air hose is not properly connected or has a leak 2. The air filter is full of dust 3. The air inlet is blocked 4. The manual pressure reducing valve is not fully closed 	<ol style="list-style-type: none"> 1. Inspect the hose and connection points 2. Replace or clean the filter 3. Clean the air inlet of the air compressor 4. Close the manual pressure reducing valve
The pressure inside does not hold	<ol style="list-style-type: none"> 1. The manual pressure reducing valve is not closed or not fully tightened 2. The air hose is not connected properly 	<ol style="list-style-type: none"> 1. Please tighten the manual pressure reducing valve 2. Inspect the connections
Abnormal noise or vibration inside the AIO unit	<ol style="list-style-type: none"> 1. The air filter is clogged 2. The air intake of the air compressor is blocked 3. The air compressor screws are loose 	<ol style="list-style-type: none"> 1. Inspect, clean or replace 2. Clean the air inlet of the air compressor 3. Tighten the screws of the air compressor
Low oxygen output	<ol style="list-style-type: none"> 1. The air filter is clogged 2. Issue with tubing 	<ol style="list-style-type: none"> 1. Clean or replace 2. Check the tubing

MAINTENANCE

Please turn off and unplug the equipment from the power outlet for any maintenance work.

GENERAL CLEANING

Wipe off the surfaces with a soft, damp microfibre towel. Using cleaning agents is allowed if they are neutral and made specifically for the materials used.

CONDENSED WATER

Regularly drain the condensed water out of the bucket. During the summer period, draining the water out may need to be done more often.

FILTER CLEANING AND REPLACEMENT - OXYGEN CONCENTRATOR

Replace the filter cotton every 8-12 months. The filters are located at the back of the units. Remove the lid to access the filters.

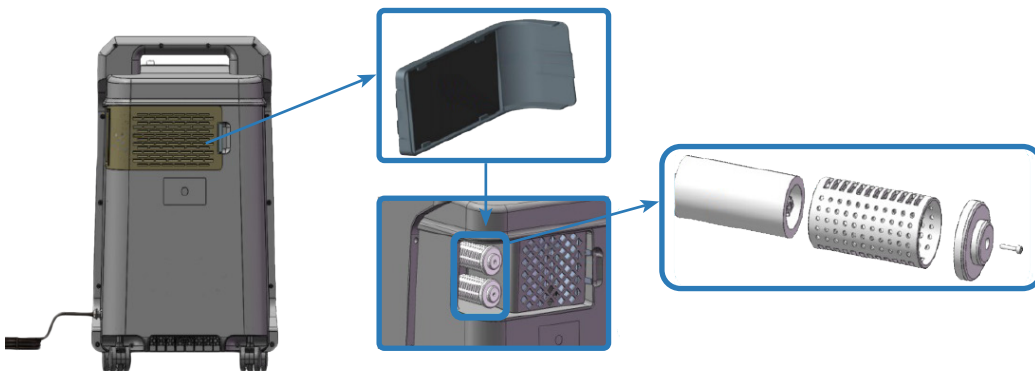

FILTER CLEANING AND REPLACEMENT - AIO UNIT/ BACK OF THE CHAMBER

The filters should be cleaned and replaced every 8-12 months.



AC MAINTENANCE - WATER REPLACEMENT

Distilled water - change every two weeks (recommended)

Tap water - change once a week.

The old water can be drained from the drain valve on the AIO unit. The filling port is located on top of the AIO unit. Fill the water up to a level where the coils are covered.

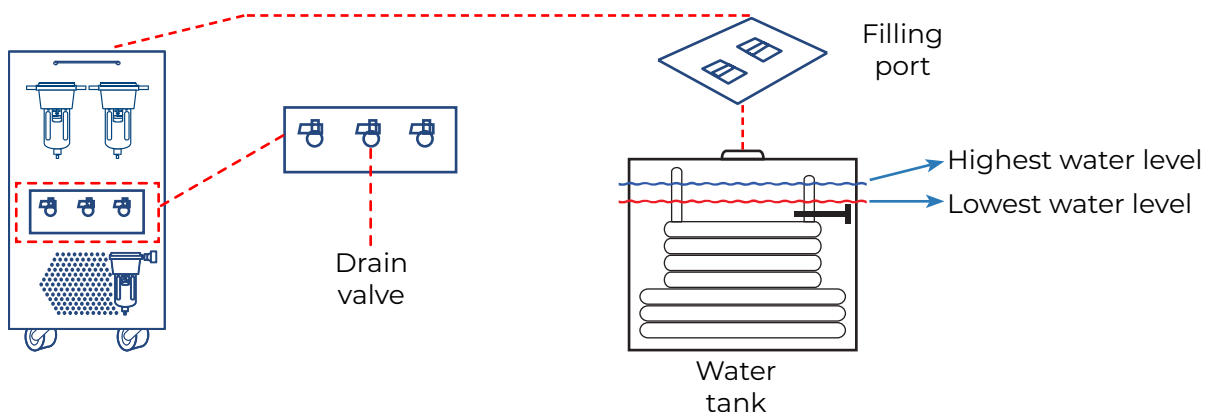

WORLD'S #1 IN SPORTS RECOVERY

CTN.FI

CTN GROUP - IRELAND - FINLAND - ESTONIA - SPAIN

CTN CENTER - JAAKONKATU 2 - 01620 VANTAA - FINLAND

SALES@CTN.FI ADMIN@CTN.FI SERVICE@CTN.FI